

LUDWIG[®]
MUSSER



LUDWIG[®]
MUSSER

Ludwig Drum Company
P.O. Box 310, Elkhart, IN 46515
www.ludwig-drums.com

INNOVATION & LEGACY

MUSSER

Welcome to the world of Ludwig/Musser Concert Percussion. The instruments in this catalog represent the finest quality and sound in percussion instruments today from a company that has been making instruments and accessories in the USA for decades. Ludwig is “The Most famous Name in Drums” since 1909 and Musser is “First in Class” for mallet percussion since 1948.

Ludwig & Musser aren’t just brand names, they are men’s names. William F. Ludwig Sr. & William F. Ludwig II were gifted percussionists and astute businessmen who were innovators in the world of percussion. Clair Omar Musser was also a visionary mallet percussionist, composer, designer, engineer and leader who founded the Musser Company to be the American leader in mallet instruments. Both companies originated in the Chicago area. They joined forces in the 1960’s and originated the concept of “Total Percussion.”

With our experience as a manufacturer, we have a dedicated staff of craftsmen and marketing professionals that are sensitive to the needs of the percussionist. Several on our staff are active percussionists today and have that same passion for excellence in design, quality and performance as did our founders. We are proud to be an American company competing in a global economy.

Musser Marimbas, Xylophones, Chimes, Bells, & Vibraphones are available in a wide range of sizes and models to completely satisfy the needs of beginners, schools, universities and professionals. With a choice of hammered copper, smooth copper or fiberglass bowls, Ludwig Timpani always deliver the full rich sound that generations of timpanists have come to expect from Ludwig. 100% Maple Concert Bass Drums, Concert Toms and Snare Drums offer the distinctive tone, projection and clarity that our reputation is built on.

Student percussion is another area where Ludwig and Musser excel. Ludwig Educational Kits combine quality and sound to give the student a great start.

This catalog also features a full line of accessories like stands, mallets, sticks and heads to get the most out of your instrument as well as covers and cases to protect your investment.

We welcome you to the Ludwig / Musser family. After you take a tour of these quality instruments and accessories in our catalog we hope that you will visit your local Ludwig / Musser dealer and hear them for yourself. We know that you rely on quality and performance and that’s what Ludwig & Musser will deliver.



MUSSEr



THE CHIEF

WILLIAM F. LUDWIG II
1916-2008

This Ludwig Musser Concert Percussion Catalog is dedicated to the late William F. Ludwig II “The Chief.” His vision for a “Total Percussion” company was something he created at Ludwig Musser and that we hold those values true to this day. As the patriarch of our company his influence as a drummer, percussionist, inventor and business leader set him apart. The Chief passed in March of 2008, but we carry on his legendary company to serve the needs of the percussionist with quality percussion instruments and accessories in sound, function and design.

MUSSER MARIMBAS



The Musser M500 rosewood marimba has a simple and secure height adjustment from 33.5" to 38". Two adjustment handles are included, to change the height of the keyboard and lock it in place.

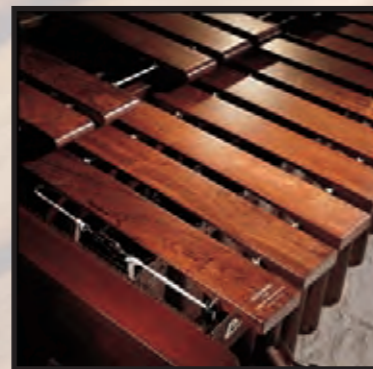
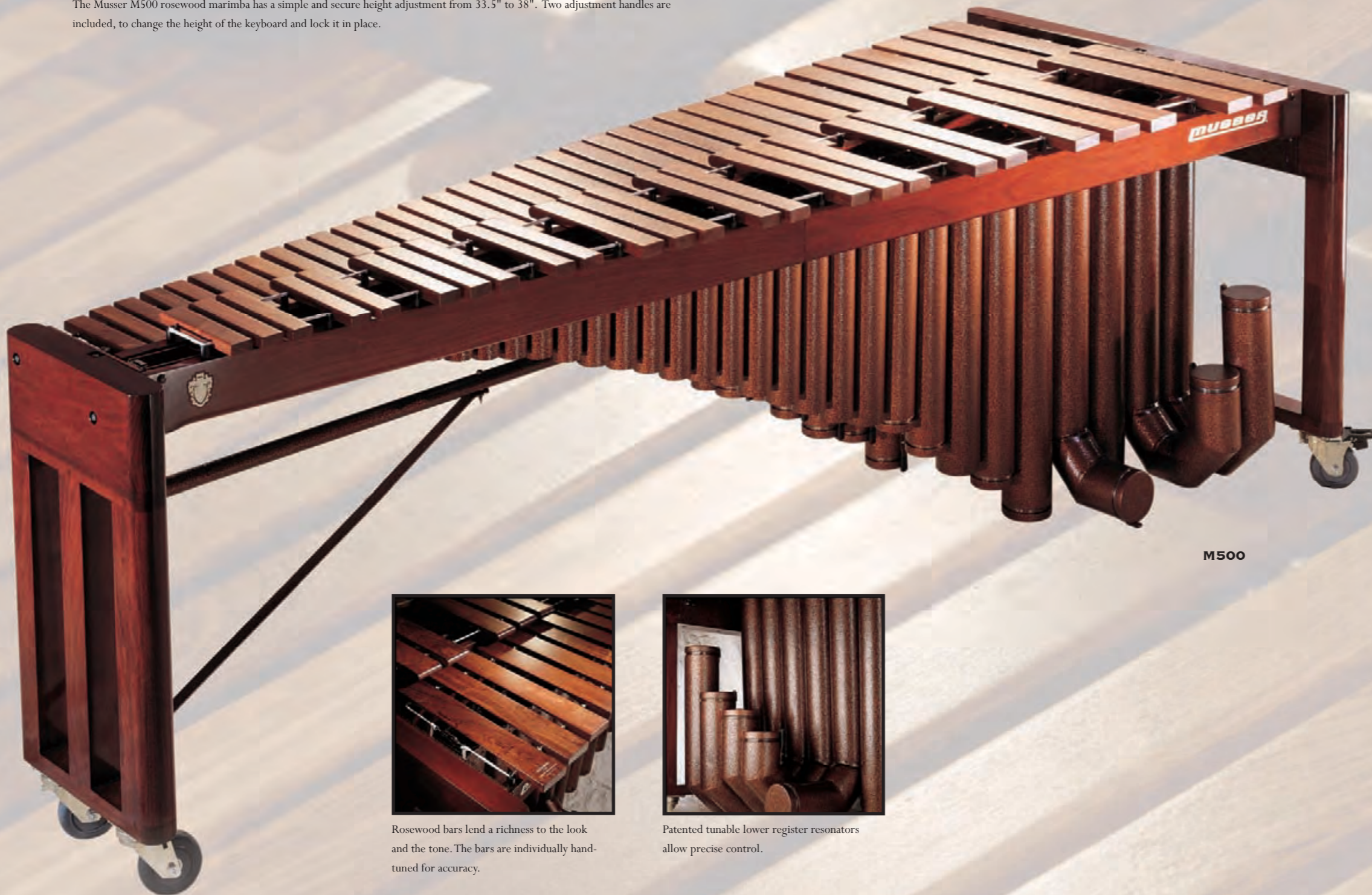

Rosewood bars lend a richness to the look and the tone. The bars are individually hand-tuned for accuracy.



Patented tunable lower register resonators allow precise control.

CONCERT GRAND SOLOIST - M500

The Concert Grand Soloist is highly regarded for its classic design and masterful, rich tone in the note range of C2-C7. A choice among professional recitalist for its presentation and tone, the 5-octave marimba features beautiful rosewood bars with rounded accidentals. In addition to impeccable tuning, M500 bars are voiced for the ultimate in consistency from bar to bar. In the voicing process, bars are selected for tone and sustain to ensure that each bar compliments its neighbors perfectly. The select wide-graduated rosewood bars provide a rich, full tone. Light staining, hand rubbing and a clear finish on the bars accentuate the beauty of the rosewood. With a furniture quality hardwood frame and copper vein powder coated resonators, the M500 Concert Grand Soloist marimba is a stunningly handsome instrument.

The M500's resonators are made from seamless tubes of aluminum alloy assembled with screws and locknuts to prevent rattles. The resonators can be set in high or low position to adjust for temperature and humidity and patented adjustable caps allow for fine tuning of individual notes from C2 to F3.

Masterfully designed for the concert performer, the entire instrument disassembles for transport. The frame is height adjustable from 33.5" - 38", with durable locking casters for smooth transport and durability. Folding resonators and rails and detachable end pieces pack securely.

Feature Name	M500
Octave Range	5 Octaves
Note Range	C2 - C7
Standard Tuning	A=442
Option Available	A=440 - A=445
Bar Material	Rosewood
Bar Graduation	Bar Graduation
Resonators	Aluminum
Tunable Resonator	Yes
Resonator Shape	Straight
Resonator Finish	Copper Vein Powder Coat
Frame Style	Wood Open End
Frame Finish	Natural Wood Stain
Height Adjustable Frame	Crank Style Height Adjustment
Shallow Drop Covers	Standard
OEM Mallets	N/A
Pro Padded Cover Option	N/A
Lined Dust Cover Option	N/A
Optional Cases	M151 (ATA), Set of 3
Low End Width	41"
High End Width	16"
Length	107"
Height	33.5" - 38"
Weight	385 lbs.

COLISEUM GRAND SOLOIST - M501

The Musser M501 Coliseum Grand Soloist 5-octave marimba features wide graduated Kelon® bars (C2-C7). The M501 marimba is state-of-the-art in frame design and delivers a full, rich, projecting sound in all registers for the keyboard. Designed for rugged use on the field or in the concert hall, large 8" pneumatic wheels provide maximum support and ease of transport. The Deluxe Moto-Cart all terrain frame is height adjustable and made from durable square steel.

A rack can be added to the M501 to easily accommodate bells, accessories. Add-on trap table and cymbal cradle are also available (See Page 36.)

COLISEUM GRAND BASS - M502

The M502 Coliseum Grand Bass Marimba features a 2-octave range (C2-C4) and sturdy steel frame. Musser offers a unique voice to the marimba family with this bass marimba. An excellent addition to any percussion ensemble.

Feature Name	M501	M502
Octave Range	5 Octaves	2 Octaves
Note Range	C2 - C7	C2 - C4
Standard Tuning	A=442	A=442
Option Available	A=440 - A=445	A=440 - A=445
Bar Material	Kelon	Kelon
Bar Graduation	Wide Graduation	Wide Graduation
Resonators	Aluminum	Aluminum
Tunable Resonators	Yes	Yes
Resonator Shape	Straight	Straight
Resonator Finish	Silver Vein Powder Coat	Silver Vein Powder Coat
Frame Style	Deluxe Moto Cart w/ Pneumatic Wheels	Deluxe Moto Cart w/ Pneumatic Wheels
Frame Finish	Matte Black	Matte Black
Height Adjustable Frame	Multi-Position Height Adjustment	Multi-Position Height Adjustment
Shallow Drop Covers	Standard	Standard
OEM Mallets	M275, M276	M275, M276
Pro Padded Cover Option	N/A	N/A
Lined Dust Cover Option	N/A	N/A
Optional Cases	N/A	N/A
Low End Width	33"	33"
High End Width	21"	21"
Length	101"	65"
Height	35" - 39"	35" - 39"
Weight	231 lbs.	165 lbs.

MUSSER MARIMBAS



M501

M502

**NEW - M300K
PERFORMER 4.3 OCTAVE SERIES MARIMBA**

Sound: Legendary Musser tuning & balance. 4.3 octave graduated Kelon® (synthetic) bars and tuned in-line resonators.

Durability: 2" welded tube steel frame with cast diagonal braces. Scratch resistant powder coat finishes on frame and resonators.

Adjustability: Gas strut assisted height adjustment from 34" to 44".

Mobility: Smooth, silent, easy rolling 8" solid rubber lockable wheels.

Flexibility: Rosewood bars available as an extra cost accessory. Accessory rail with two clamps included. Clamps can be mounted to cart sides, cross-bar or accessory rail.



M300K



M7360



Clamp
E97725

Accessory clamps are rotatable to 90 degrees for flexible positioning and can accommodate 1/2" to 1 1/4" round tube accessories mounted anywhere on frame.

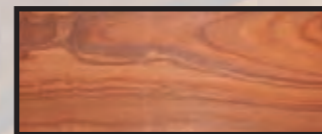

Rosewood Bar
E4134FUL
Rosewood bar set.

Feature Name	M7365	M7360
Octave Range	4.5 Octaves	4.3 Octaves
Note Range	F2 - C7	A2 - C7
Standard Tuning	A=442	A=442
Option Available	A=440 - A=445	A=440 - A=445
Bar Material	Kelon	Kelon
Bar Graduation	Wide Graduation	Wide Graduation
Resonators	Aluminum	Aluminum
Tunable Resonators	N/A	N/A
Resonator Shape	Straight	Straight
Resonator Finish	Silver Powder Coat	Silver Powder Coat
Frame Style	Height Adjustable Moto-Cart	Height Adjustable Moto-Cart
Frame Finish	Black	Black
Height Adjustable Frame	Multi-Position	Multi-Position
Shallow Drop Covers	Standard	Standard
OEM Mallets	M229	M229
Pro Padded Cover Option	M135MB	M130MB
Lined Dust Cover Option	M235MB	M230MB
Optional Cases	N/A	N/A
Low End Width	36"	31"
High End Width	16"	18"
Length	87"	81"
Height	36.5"	36.5"
Weight	272 lbs.	244 lbs.

CLASSIC GRAND - M7360

SYMPHONIC GRAND - M7365

The M7360 Classic Grand and M7365 Symphonic Grand Kelon Marimbas are ready to take the field with 8" pneumatic swivel tires and gas strut height adjustable frames made from heavy duty 2" square steel. There are 6 positions of heights available in one inch increments. In addition, the frames on the M7365 & M7360 have "outriggers" where the wheel base can be expanded outward for increased stability. That becomes important when adding rack systems to the frame to support add on bells, snare drums, cymbals, etc. These marimbas are built for the "front ensemble" of the marching field and offer the ultimate in durability.

**MUSSEY
MARIMBAS**

MUSSER MARIMBAS



DELUXE STUDIO GRAND - M245 CONCERT GRAND - M250

Musser makes two 4.3 octave rosewood marimbas. The M250 Concert Grand is a classic marimba that is a longtime favorite of symphonies and universities. M250 bars are triple tuned and voiced to ensure consistent sustain throughout the keyboard. The resonators are made from drawn seamless aluminum tubing for unimpaired projection. Each tube is capped precisely for maximum sustain. The front row is arched and mitered and the set is gold powder coated for a classic look.

The M245 Deluxe Studio Grand has open end pieces and straight cut resonators for a more contemporary look. The rosewood bars are triple tuned and have a satin finish.



Resonators on Concert Grand are individually precision tuned, arched and mitered for that classic Musser look.

Feature Name	M250	M245
Octave Range	4.3 Octaves	4.3 Octaves
Note Range	A2 - C7	A2 - C7
Standard Tuning	A=442	A=442
Option Available	A=440 - A=445	A=440 - A=445
Bar Material	Rosewood	Rosewood
Bar Graduation	Wide Graduation	Wide Graduation
Resonators	Aluminum	Aluminum
Tunable Resonators	N/A	N/A
Resonator Shape	Arched & Mitered	Straight In Line
Resonator Finish	Gold Powder Coat	Silver Vein Powder Coat
Frame Style	Wood Closed End w/ Vinyl Wrap	Wood Open End
Frame Finish	Black Gloss	Black Plextone
Height Adjustable Frame	N/A	N/A
Shallow Drop Covers	Standard	Standard
OEM Mallets	M229	M229
Pro Padded Cover Option	M130MB	M130MB
Lined Dust Cover Option	M230MB	M230MB
Optional Cases	M148, Set of 5	N/A
Low End Width	33.5"	32"
High End Width	15.5"	15"
Length	82"	81.5"
Height	33.75"	35"
Weight	180 lbs.	165 lbs.

STUDIO GRAND - M240

The M240 Studio Grand marimba uses the same frame and resonators as the M245 but with Padauk bars. Padauk is slightly less dense than rosewood but offers the natural response and character of wood for at an affordable price, making the M240 a great teaching studio or rehearsal room instrument.



Silver Vein Powder Coated resonators

Feature Name	M240
Octave Range	4.3 Octaves
Note Range	A2 - C7
Standard Tuning	A=442
Option Available	A=460 - A=445
Bar Material	Paduk
Bar Graduation	Wide Graduation
Resonators	Aluminum
Tunable Resonators	N/A
Resonator Shape	Straight In Line
Resonator Finish	Silver Vein Powder Coat
Frame Style	Wood Open End
Frame Finish	Black Plextone
Height Adjustable Frame	N/A
Shallow Drop Covers	Standard
OEM Mallets	M229
Pro Padded Cover Option	M130MB
Lined Dust Cover Option	M230MB
Optional Cases	N/A
Low End Width	32"
High End Width	15"
Length	81.5"
Height	35"
Weight	170 lbs.

MUSSER MARIMBAS



Oval shaped aluminum resonators for deep rich sound.

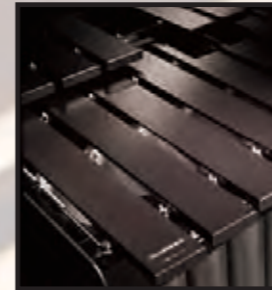

Kelon bars are a Musser exclusive, developed to keep their tone regardless of temperature and humidity. Kelon produces warm mellow tone and dynamic response.

The versatility of the Symphonic Grand and Classic Grand marimbas allows the percussionist to perform in any environment. Wide graduated Kelon® bars, a Musser exclusive, deliver superb tone that is highly resistant to changes in temperature and humidity. The marimbas produce rich, mellow sound, whether supported on the wood concert frame, or the sturdy steel Moto Cart.

SYMPHONIC GRAND - M350, M365

Symphonic Grand models M350 and M365 are meticulously crafted to produce 4.5 octaves in an extended low F2-C7 note range. With carefully tuned silver powder coated aluminum resonators the Symphonic Grand also features dual resonator track positioning.

Feature Name	M350	M365
Octave Range	4.5 Octaves	4.5 Octaves
Note Range	F2 - C7	F2 - C7
Standard Tuning	A=442	A=442
Option Available	A=440 - A=445	A=440 - A=445
Bar Material	Kelon	Kelon
Bar Graduation	Wide Graduation	Wide Graduation
Resonators	Aluminum	Aluminum
Tunable Resonators	N/A	N/A
Resonator Shape	Straight	Straight
Resonator Finish	Silver Powder Coat	Silver Powder Coat
Frame Style	Wood Open End	Moto Cart
Frame Finish	Black Plextone	Black
Height Adjustable Frame	N/A	N/A
Shallow Drop Covers	Standard	Standard
OEM Mallets	M229	M229
Pro Padded Cover Option	M135MB	M135MB
Lined Dust Cover Option	M235MB	M235MB
Optional Cases	M155 for M350 only, Set of 5	N/A
Low End Width	34"	36"
High End Width	16"	16"
Length	86"	87"
Height	35.5"	36.5"
Weight	218 lbs.	218 lbs.

CLASSIC GRAND - M300, M360

Classic Grand models M300 and M360, in the 4.3 octave, A2-C7 range, are adaptable to either the field pit or orchestra stage. The Classic Grand on a concert frame features gold finished, arched and mitered resonators. The M360 marimba with a Moto Cart frame includes straight, durable silver vein resonators.

Feature Name	M300	M360
Octave Range	4.3 Octaves	4.3 Octaves
Note Range	A2 - C7	A2 - C7
Standard Tuning	A=442	A=442
Option Available	A=440 - A=445	A=440 - A=445
Bar Material	Kelon	Kelon
Bar Graduation	Wide Graduation	Wide Graduation
Resonators	Aluminum	Aluminum
Tunable Resonators	N/A	N/A
Resonator Shape	Arched & Mitered	Straight
Resonator Finish	Gold Powder Coat	Silver Powder Coat
Frame Style	Wood Open End	Moto Cart
Frame Finish	Black Plextone	Black
Height Adjustable Frame	N/A	N/A
Shallow Drop Covers	Standard	Standard
OEM Mallets	M229	M229
Pro Padded Cover Option	M130MB	M130MB
Lined Dust Cover Option	M230MB	M230MB
Optional Cases	M157 for M300 only, Set of 5	N/A
Low End Width	32"	31"
High End Width	15.5"	18"
Length	82"	81"
Height	36.5"	36.5"
Weight	195 lbs.	205 lbs.

MUSSER MARIMBAS



Feature Name	M31	M7031	M8031	M61	M7061	M8061
Octave Range	4 Octaves	4 Octaves	4 Octaves	3 Octaves	3 Octaves	3 Octaves
Note Range	C2 - C7	C2 - C7	C2 - C7	F3 - F6	F3 - F6	F3 - F6
Standard Tuning	A=442	A=442	A=442	A=442	A=442	A=442
Option Available	A=440 - A=445	A=440 - A=445	A=440 - A=445	A=440 - A=445	A=440 - A=445	A=440 - A=445
Bar Material	Kelon	Kelon	Kelon	Kelon	Kelon	Kelon
Bar Graduation	Non-Graduated	Non-Graduated	Non-Graduated	Non-Graduated	Non-Graduated	Non-Graduated
Resonators	Aluminum	Aluminum	Aluminum	Aluminum	Aluminum	Aluminum
Tunable Resonators	N/A	N/A	N/A	N/A	N/A	N/A
Resonator Shape	Straight	Straight	Straight	Straight	Straight	Straight
Resonator Finish	Silver Vein Powder Coat	Silver Vein Powder Coat	Silver Vein Powder Coat	Silver Powder Coat	Silver Powder Coat	Silver Powder Coat
Frame Style	Concert Frame (Wood w/ Folding Aluminum Legs and 3" Casters)	Moto Cart (2" Square Steel w/ 5" Casters)	All Terrain Cart (1.5" Square Steel Frame w/ 8" Pneumatic Tires)	Concert Frame (Wood w/ Folding Aluminum Legs and 3" Casters)	Moto Cart (2" Square Steel w/ 5" Casters)	All Terrain Cart (1.5" Square Steel Frame w/ 8" Pneumatic Tires)
Frame Finish	Black Plextone	Black	Black	Black Plextone	Black	Black
Height Adjustable Frame	5 Position	N/A	6 Position	5 Position	N/A	6 Position
Shallow Drop Covers	Standard	Standard	Standard	Standard	Standard	Standard
OEM Mallets	M8, M25	M8, M25	M8, M25	M1, M8	M1, M8	M1, M8
Pro Padded Cover Option	M131MB	M135MB	M131MB	M161MB	M161MB	M161MB
Lined Dust Cover Option	M231MB	N/A	N/A	M261MB	N/A	N/A
Optional Cases	M136 for M31 only, Set of 3	N/A	N/A	M135 for M61 only, Set of 2	N/A	N/A
Low End Width	31"	30.5"	31"	28"	31"	28"
High End Width	12"	17"	12"	13"	17"	12"
Length	61.5"	63"	70"	46"	46.5"	53.5"
Height	32"-36.5"	35.5"	32.5"-39.5"	32"-36.5"	35.5"	31.5"-38.5"
Weight	100 lbs.	150 lbs.	240 lbs.	75 lbs.	150 lbs.	230 lbs.

WINDSOR II - M31

Superb sound and easy portability make the 4 octave Windsor II with non-graduated Kelon bars an ideal marimba for the traveling professional or student. Oval aluminum resonators with silver vein powder coat finish provide excellent resonance as well as added durability. Available with a height adjustable concert frame as model M31, on a Moto Cart frame as model M7031 or on an All Terrain frame with pneumatic tires as model M8031.

TRIETTE - M61

The Triette has many of the same features as the Windsor II but in a smaller, 3 octave package with round tube resonators. Available with a height adjustable concert frame as model M61, on a Moto Cart Frame as model M7061 or on an All Terrain frame with pneumatic tires as model M8061.

WINDSOR II & TRIETTE WITH MOTO CART AND ALL-TERRAIN CART

In addition to the standard concert frame, the Windsor II and Triette marimbas are available with the Moto Cart and All-Terrain Cart, to provide a range of applications. The Moto Cart features 2" square steel construction for solid support. Adding to its versatility, the Moto Cart can accommodate add-on accessories and rack systems. The All-Terrain Cart, ideal for outdoor applications, features 8" pneumatic wheels to move the cart smoothly over any surface. The All-Terrain Cart is also built for add-on accessories and rack systems.

MUSSER VIBRAPHONES



M75



M75LH

CENTURY - M75

An elegant testimony to Musser craftsmanship, the Century Vibe is preferred by leading artists throughout the world. The 3-octave concert vibraphone offers unmatched warmth and resonance. Gold finished bars are perfectly tuned and gold powder-coated resonators are arched and mitered for superb projection. Covered wood end panels create a resonating chamber for a richer, more mellow sound. The Century also features a wide sustain pedal and variable speed motor.

Feature Name	M75
Multi-Speed Motor	Yes
Octave Range	3 Octaves
Note Range	F3 - F6
Standard Tuning	A=442
Option Available	A=440 - A=445
Bar Material	Aluminum
Bar Finish	Gold
Bar Graduation	Wide Graduation
Resonators	Aluminum
Resonator Shape	Arched & Mitered
Resonator Finish	Gold Powder Coat
Frame Style	Wood Closed End

Frame Finish	Black Gloss
Height Adjustable Frame	N/A
Shallow Drop Covers	Standard
OEM Mallets	M235
Pro Padded Cover Option	M155VB
Lined Dust Cover Option	M255VB
Optional Cases	M141, Set of 5
Low End Width	30"
High End Width	15.5"
Length	56.5"
Height	34.5"
Weight	175 lbs.

LIONEL HAMPTON SIGNATURE CENTURY - M75LH

A tribute to the legendary jazz musician, the Lionel Hampton Signature Vibraphone is based on the M75 but features a beautifully finished wood frame and antique gold finished resonators.

Feature Name	M75LH
Multi-Speed Motor	Yes
Octave Range	3 Octaves
Note Range	F3 - F6
Standard Tuning	A=442
Option Available	A=440 - A=445
Bar Material	Aluminum
Bar Finish	Gold
Bar Graduation	Wide Graduation
Resonators	Aluminum
Resonator Shape	Arched & Mitered
Resonator Finish	Hampton Gold Antique
Frame Style	Wood Open End

Frame Finish	Natural Wood Stain
Height Adjustable Frame	N/A
Shallow Drop Covers	Standard
OEM Mallets	M235
Pro Padded Cover Option	M155VB
Lined Dust Cover Option	M255VB
Optional Cases	M141, Set of 5
Low End Width	30"
High End Width	15.5"
Length	56.5"
Height	34.5"
Weight	170 lbs.

MUSSER VIBRAPHONES



M55



M7055



M7055G



M55G

PRO-VIBE

The touring professionals' choice of vibraphones, the 3-octave Pro-Vibe was designed for peak performance and easy portability. Hand tuned bars and seamless arched and mitered resonators produce a rich and resonant tone. Adjustable, swiveling sustain pedal offers precise feel and the variable speed motor is insulated for quiet operation. An adjustable damper bar and Musser distortion-free bar suspension system assure exact control. Available in durable silver powder coat finish or lustrous satin gold, the Pro-Vibe makes a stunning impression on the concert stage or playing field. Stands include a height adjustable concert style frame with folding aluminum legs, Moto Cart with 2" steel frame, or the All-Terrain Cart featuring 8" pneumatic wheels for smooth transportability.



Musser Variable Speed Electric Vibe Motor Control.



Lustrous silver satin finish on aluminum bars. (Available on the Pro-Vibe and Pro-Traveler.)

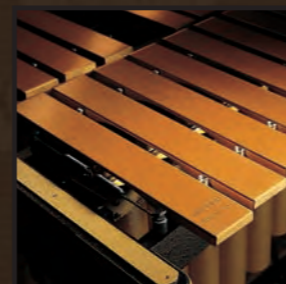

Bars with satin gold finish. (Available on the Century, Pro and Pro-Traveler Vibe.)



M8055

Pro-Vibe with All-Terrain cart is ideal for marching field as well as the concert stage.

Feature Name	M55/M55G	M7055/M7055G	M8055/M8055G
Multi-Speed Motor	Yes	Yes	Yes
Octave Range	3 Octaves	3 Octaves	3 Octaves
Note Range	F3 - F6	F3 - F6	F3 - F6
Standard Tuning	A=442	A=442	A=442
Option Available	A=440 - A=445	A=440 - A=445	A=440 - A=445
Bar Material	Aluminum	Aluminum	Aluminum
Bar Finish	Silver/Gold	Silver/Gold	Silver/Gold
Bar Graduation	Wide Graduated	Wide Graduated	Wide Graduated
Resonators	Aluminum	Aluminum	Aluminum
Resonator Shape	Arched & Mitered	Arched & Mitered	Arched & Mitered
Resonator Finish	Silver Powder Coat/ Gold Powder Coat	Silver Powder Coat/ Gold Powder Coat	Silver Powder Coat/ Gold Powder Coat
Frame Style	Wood Frame Folding Aluminum Legs w/ 3" Casters	Moto Cart (2" Square Steel w/ 5" Casters)	All Terrain Cart w/ 8" Pneumatic Tires (1.5" Square Steel)
Frame Finish	Black Plextone	Black	Black
Height Adjustable Frame	5 Position	N/A	6 Position
Shallow Drop Covers	Standard	Standard	Standard
OEM Mallets	M235	M235	M235
Pro Padded Cover Option	M155VB	N/A	N/A
Lined Dust Cover Option	M255VB	N/A	N/A
Optional Cases	M149, Set of 3	N/A	N/A
Low End Width	30"	31"	31"
High End Width	15.5"	17"	15.5"
Length	56"	56.5"	63.5"
Height	32"-36"	35.5"	32.5"-39.5"
Weight	137 lbs.	187 lbs.	170 lbs.

MUSSER VIBRAPHONES

MUSSER/PIPER - M58M

A collaboration between Musser engineers and John Piper, the Musser/Piper vibe uses the same bars as an M55 Pro Vibe but puts them on an innovative frame with great adjustability and features. The Piper Cushion damper is fluid filled to apply pressure evenly to every bar and is placed on a damper bar with dual springs for exacting adjustment of pressure from side to side. Thumbwheel adjustments allow for precise height adjustment of the resonators. Telescoping uprights allow 10 inches of height adjustment and large handles make locking everything in place easy. The damper pedal can be moved left and right in the frame to accommodate different playing styles. Large total lock casters make moving the Piper vibe easy and once locked down, they keep it exactly where you put it. Available with a variable speed motor as M58M or without a motor as M58.



The dual action adjustable compression spring balances the damper pressure for even and smooth action.



The aluminum anodized frame with large ratchet style handles has telescoping parts for quick comfort adjustment.



Variable height resonators adjust volume and allow for fine tuning in various climatic conditions.



Adjustable damper pedal easily slides from left to right for players' comfort.

M58M

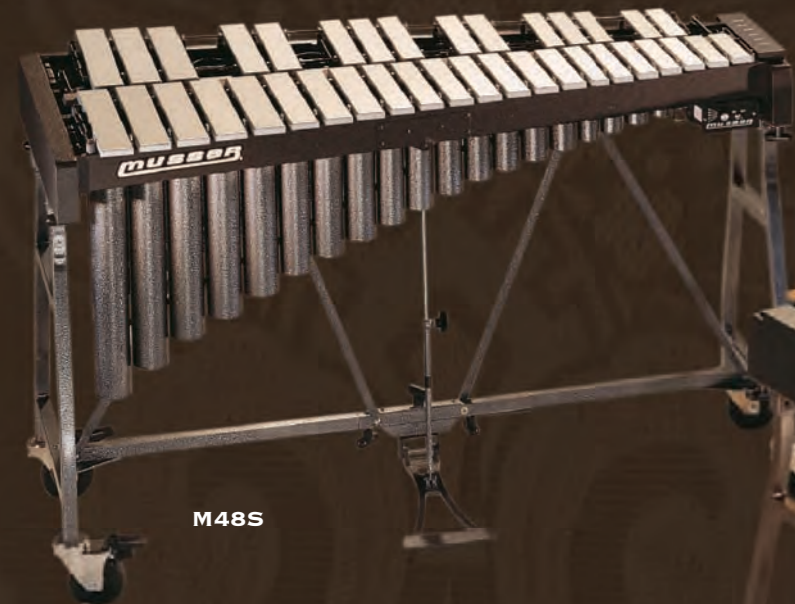
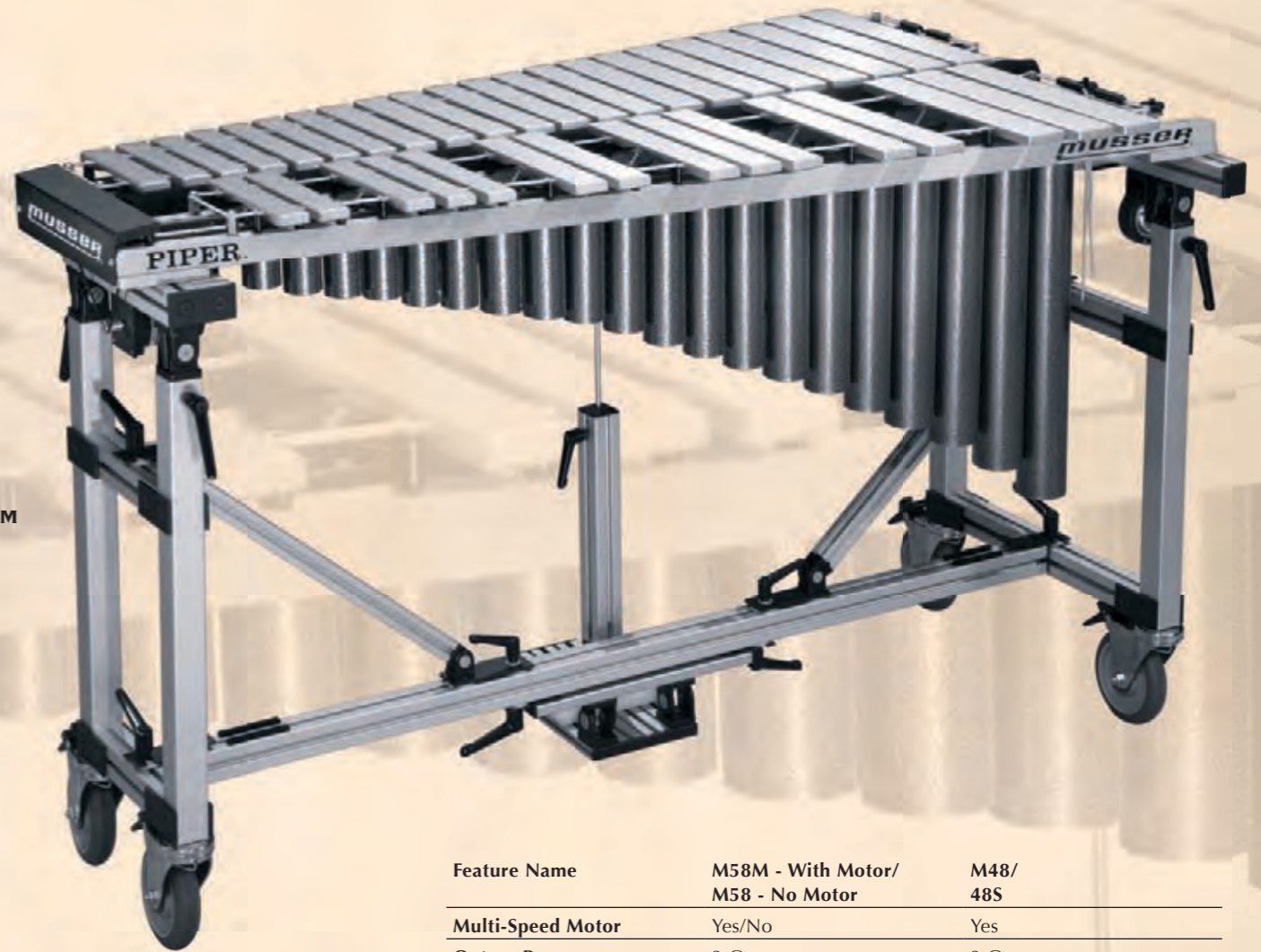

M48S



M48

PRO-TRAVELER - GOLD (M48), SILVER (M48S)

Pro-TravelerVibe is an ingenious collaborative effort between Musser and acclaimed vibist Gary Burton. A remarkable combination of superb musicality and easy portability, the Pro-Traveler completely disassembles to fit in storage areas as compact as a car back seat. Crossbar and damper mechanisms separate into smaller pieces. Metal legs detach quickly and frame rails fold in half. All components are durable, including the baked-on frame finish with Total Lock casters. The 3-octave vibraphone features wide graduated aluminum bars finished in either gold or silver. The perfect instrument for the gigging vibist.



Fluid filled damper cushion distributes pressure evenly to all bars

Feature Name	M58M - With Motor/ M58 - No Motor	M48/ 48S
Multi-Speed Motor	Yes/No	Yes
Octave Range	3 Octaves	3 Octaves
Note Range	F3 - F6	F3 - F6
Standard Tuning	A=442	A=442
Option Available	A=440 - A=445	A=440 - A=445
Bar Material	Aluminum	Aluminum
Bar Finish	Silver	Gold/Silver
Bar Graduation	Wide Graduated	Wide Graduated
Resonators	Aluminum	Aluminum
Resonator Shape	Straight	Straight
Resonator Finish	Silver Vein Powder Coat	Gold Vein Powder Coat/ Silver Powder Coat
Frame Style	Aluminum	Wood Frame w/ Removable Aluminum Legs
Frame Finish	Aluminum	Black Plextone
Height Adjustable Frame	Telescoping Height Adjustment	N/A
Shallow Drop Covers	Standard	Standard
OEM Mallets	M235	M235
Pro Padded Cover Option	N/A	M155VB
Lined Dust Cover Option	M255VB	M255VB
Optional Cases	M258 (ATA), Set of 3	M138, Set of 3
Optional Gig Bags	N/A	M137 Bags, Set of 5
Low End Width	30"	29"
High End Width	11"	15"
Length	57"	56"
Height	34"-44"	35.5"
Weight	240 lbs./235 lbs.	140 lbs.

MUSSER VIBRAPHONES



ONE-NIGHTER

The One-Nighter Vibe is ideal for the student and the professional gigging vibes player. The 3-octave vibraphone has all the features of a professional instrument, including wide graduated bars finished with a special ball burnishing in a lustrous silver finish. The damper pedal mechanism is height adjustable to keep the angle of the pedal even for proper playing technique. Aluminum resonators are not arched or mitered and are finished in a scratch resistant silver vein powder coating for durability. Designed for portability, the aluminum and wood frame is height adjustable to five different positions and is also equipped with M-braces for added stability. One-Nighter with Moto Cart (M7046), is ideal for marching bands and drum corps.

Feature Name	M46/M46M Concert Frame One-Nighter	M7046/M7046M Moto Cart Frame One-Nighter	M8046/M8046M All-Terrain Cart One-Nighter
Multi-Speed Motor	No/Yes	No/Yes	No/Yes
Octave Range	3 Octaves	3 Octaves	3 Octaves
Note Range	F3 - F6	F3 - F6	F3 - F6
Standard Tuning	A=442	A=442	A=442
Option Available	A=440 - A=445	A=440 - A=445	A=440 - A=445
Bar Material	Aluminum	Aluminum	Aluminum
Bar Finish	Silver Burnished	Silver Burnished	Silver Burnished
Bar Graduation	Wide Graduated	Wide Graduated	Wide Graduated
Resonators	Aluminum	Aluminum	Aluminum
Resonator Shape	Straight	Straight	Straight
Resonator Finish	Silver Vein Powder Coat	Silver Vein Powder Coat	Silver Vein Powder Coat
Frame Style	Wood Frame Folding Aluminum Legs	Moto Cart (2" Square Steel)	All Terrain Cart Pneumatic Wheel (1.5" Square Steel)
Frame Finish	Black Plextone	Black	Black
Height Adjustable Frame	5 Position	N/A	6 Position
Shallow Drop Covers	Standard	Standard	Standard
OEM Mallets	M235	M235	M235
Pro Padded Cover Option	M155VB	N/A	N/A
Lined Dust Cover Option	M255VB	N/A	N/A
Optional Cases	M149, Set of 3	N/A	N/A
Low End Width	30"	31"	31"
High End Width	15.5"	17"	15.5"
Length	56"	56.5"	63.5"
Height	32"-36"	35.5"	32.5"-39.5"
Weight	130 lbs./140 lbs.	165 lbs./185 lbs.	165 lbs./170 lbs.

COMBO VIBE

The 3-octave Combo® Vibe produces exceptional sound and performance for students at a scaled down cost. Silver burnished aluminum bars are carefully tuned and aluminum resonators are finished with silver powder coat for durability and scratch resistance. Other features include a tension-adjustable damper bar and a dependable single speed motor with a three speed pulley. The height adjustable wood concert frame has folding aluminum legs for easy transport. The Combo® vibraphone with the Moto Cart is made of heavy-gauge 2" square black-finished steel and is braced for rugged applications. The vibraphone is also available with the All-Terrain Cart that features 8" pneumatic wheels for smooth transport over rough terrain. Made of 1 1/2" square steel, the cart is height and length adjustable.



Feature Name	M44 Concert Frame Combo®	M7044 Moto Cart Combo®	M8044 All-Terrain Cart Combo®
Multi-Speed Motor	Yes	Yes	Yes
Octave Range	3 Octaves	3 Octaves	3 Octaves
Note Range	F3 - F6	F3 - F6	F3 - F6
Standard Tuning	A=442	A=442	A=442
Option Available	A=440 - A=445	A=440 - A=445	A=440 - A=445
Bar Material	Aluminum	Aluminum	Aluminum
Bar Finish	Silver Burnished	Silver Burnished	Silver Burnished
Bar Graduation	Non-Graduated	Non-Graduated	Non-Graduated
Resonators	Aluminum	Aluminum	Aluminum
Resonator Shape	Straight	Straight	Straight
Resonator Finish	Silver Powder Coat	Silver Powder Coat	Silver Powder Coat
Frame Style	Wood Frame Folding Aluminum Legs	Moto Cart (2" Square Steel)	All Terrain Cart Pneumatic Wheel (1.5" Square Steel)
Frame Finish	Black Plextone	Black	Black
Height Adjustable Frame	5 Position	N/A	6 Position
OEM Mallets	M1, M8	M1, M8	M1, M8
Pro Padded Cover Option	M161MB	N/A	N/A
Lined Dust Cover Option	M261MB	N/A	N/A
Optional Cases	M180, Set of 2	N/A	N/A
Low End Width	28"	31"	27.5"
High End Width	15.5"	17"	15.5"
Length	42"	42.5"	49.5"
Height	32"-36"	35.5"	32.5"-39.5"
Weight	75 lbs.	120 lbs.	116 lbs.

MUSSER XYLOPHONES

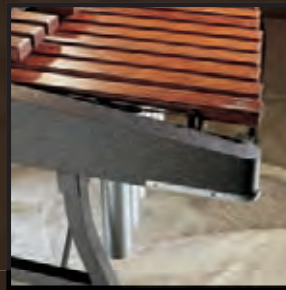

Rosewood bars deliver full rich tone. Slant style frame for Glissando effects.



M50



M51



M7051



M8051

M8042



M42



M7042

PRO-PORTABLE KELON

The Pro-Portable xylophone features Musser exclusive Kelon® bars which resist changes in temperature and humidity to maintain tonal quality and dynamite response. The 3.5 octave xylophone has silver powder coated seamless aluminum resonators. With excellent portability features, the xylophone adapts to any environment. Detachable resonators and folding aluminum legs on the wood concert frame make it easy to transport. The Pro-Portable xylophone is also available with the Moto Cart frame or the All-Terrain Cart.

ELITE

The Elite xylophone also features the exclusive 3-octave Kelon® bars. Ideal for students, the Elite hand tuned resonators deliver superb tone and resonance. With folding aluminum legs and light-weight concert frame, the Elite is extremely portable. The Elite is also available with the Moto Cart frame and the All-Terrain Cart.

PRO-PORTABLE ROSEWOOD

The portable professional xylophone from Musser features triple-tuned rosewood bars. To bring out the natural beauty of the wood, the bars are lightly stained and lacquered. Detachable resonators are silver powder coated aluminum for durability and scratch resistance. The 3.5-octave rosewood xylophone has a wood frame with folding aluminum legs and five position height adjustments.

PICCOLO KELON XYLOPHONE M39 / M8039

A lightweight, portable piccolo Kelon Xylophone offering a full 3 octave keyboard that is ideally suited for the professional show percussionist or for use in schools. Kelon bars are mounted on a sturdy frame built into a deluxe carrying case with removable top. The M8039 is the M39 with the M8005 Bell Cart.



M8039

M39

Feature Name	M50 Concert Frame Pro-Portable Rosewood	M51 Concert Frame Pro-Portable Kelon	M7051 Moto Cart Frame Pro-Portable Kelon	M8051 All-Terrain Cart Pro-Portable Kelon	M42 Concert Frame Elite	M7042 Moto Cart Frame Elite	M8042 All-Terrain Frame Elite	M39 Case Only Piccolo	M8039 Case on Cart Piccolo
Octave Range	3.5 Octaves	3.5 Octaves	3.5 Octaves	3.5 Octaves	3 Octaves	3 Octaves	3 Octaves	3 Octaves	3 Octaves
Note Range	F4 - C8	F4 - C8	F4 - C8	F4 - C8	C5 - C8	C5 - C8	C5 - C8	C5 - C8	C5 - C8
Standard Tuning	A=442	A=442	A=442	A=442	A=442	A=442	A=442	A=442	A=442
Option Available	A=440 - A=445	A=440 - A=445	A=440 - A=445	A=440 - A=445	A=440 - A=445	A=440 - A=445	A=440 - A=445	A=440 - A=445	A=440 - A=445
Bar Material	Rosewood	Kelon	Kelon	Kelon	Kelon	Kelon	Kelon	Kelon	Kelon
Bar Graduation	Non-Graduated	Non-Graduated	Non-Graduated	Non-Graduated	Non-Graduated	Non-Graduated	Non-Graduated	Non-Graduated	Non-Graduated
Resonators	Aluminum	Aluminum	Aluminum	Aluminum	Aluminum	Aluminum	Aluminum	N/A (In Case)	N/A (In Case)
Resonator Shape	Straight	Straight	Straight	Straight	Straight	Straight	Straight	N/A	N/A
Resonator Finish	Silver Powder Coat	Silver Powder Coat	Silver Powder Coat	Silver Powder Coat	Silver Powder Coat	Silver Powder Coat	Silver Powder Coat	N/A	N/A
Frame Style	Wood Frame Folding Aluminum Legs	Wood Frame Folding Aluminum Legs	Moto Cart (2" Steel, 5" Casters)	All-Terrain Cart (1.5" Steel, 8" Pneumatic)	Wood Frame Folding Aluminum Legs	Moto Cart (2" Square Steel, 5" Casters)	All-Terrain Cart Pneumatic Wheels (1.5" Square Steel)	In Case (No Legs) Must be put on stand or cart	In Case w/M8005 Cart on Wheels
Frame Finish	Black Plextone	Black Plextone	Black	Black	Black Plextone	Black	Black	Black Plextone	Black
Height Adjustable Frame	5 Position	5 Position	N/A	6 Position	5 Position	N/A	6 Position	N/A	6 Position
Shallow Drop Covers	Standard	Standard	Standard	Standard	Standard	Standard	Standard	N/A Case Included	N/A Case Included
OEM Mallets	M22, M15	M4, M5	M4, M5	M4, M5	M4, M3	M4, M3	M4, M3	M4, M3	M4, M3
Pro Padded Cover Option	M151XY	M151XY	M151XY	M151XY	M142XY	N/A	N/A	N/A	N/A
Lined Dust Cover Option	M251XY	M251XY	M251XY	M251XY	M242XY	N/A	N/A	N/A	N/A
Optional Cases	M146, Set of 3	M146, Set of 3	N/A	N/A	M147 Set of 2	N/A	N/A	Included	Included
Low End Width	30.5"	30.5"	31"	30.375"	28"	31"	28"	24.5"	24.5"
High End Width	11.5"	11.5"	17"	12"	12"	17"	12"	12.5"	12/5"
Length	53.5"	53.5"	54.5"	59.5"	46.5"	46.5"	53.5"	45"	45"
Height	32"-36"	32"-36"	35.5"	32.5"-36.5"	32"-36"	35.5"	31.5" - 38.5"		27" - 34"
Weight	100 lbs.	100 lbs.	150 lbs.	150 lbs.	83 lbs.	133 lbs.	113 lbs.	50 lbs.	60 lbs.



MUSSER ORCHESTRAL BELLS



MUSSER BELL LYRAS

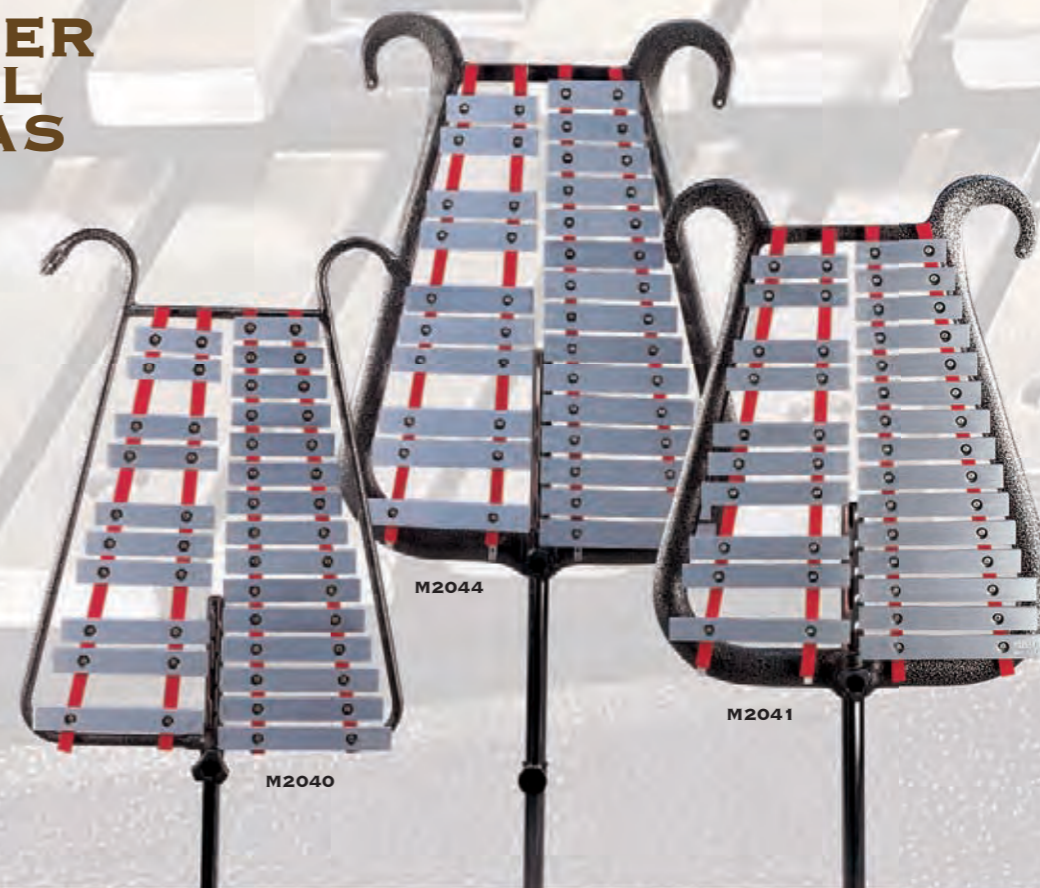

Musser's Classic Bells are the finest high-carbon tempered steel, carefully hand tuned with a specially designed bar mounting system to deliver unsurpassed tone, clarity and resonance. The 2.5-octave bars are nickel plated with a satin finish. An optional hand damper on the M646 allows superb control over intricate passages. Classic Bells have a vinyl covered wood case with sturdy steel hinges, latches and double handles for carrying security. Optional stands include a folding table and a compact folding stand. Another option is the small mallet instrument cart with large swivel casters. The cart is height and length adjustable and retrofits small instrument accessories.

Feature Name	M645 Classic	M646 Classic	M656 Classic
Octave Range	2.5 Octaves	2.5 Octaves	2.5 Octaves
Note Range	G5 - C8	G5 - C8	G5 - C8
Standard Tuning	A=442	A=442	A=442
Option Available	A=440 - A=445	A=440 - A=445	A=440 - A=445
Bar Material	Steel	Steel	Aluminum
Bar Graduation	Non-Graduated	Non-Graduated	Non-Graduated
Case	Wood w/ Vinyl Wraps, Steel Hinges, Latches	Wood w/ Vinyl Wraps, Steel Hinges, Latches	Wood w/ Vinyl Wraps, Steel Hinges, Latches
Damper	N/A	Yes	N/A
OEM Mallets	M14, M23	M14, M23	M14, M23
Bell Stand Option	LE1368, LFP302BKS	LE1368, LFP302BKS	LE1368, LFP302BKS
Bell Cart Option	M8005	M8005	M8005
Low End Width	21"	21"	21"
High End Width	11"	10.5"	11"
Length	32"	31"	32"
Depth	3.5"	3.5"	3.5"
Weight	43 lbs.	44 lbs.	29 lbs.



Shown with standard vinyl-wrapped wood case. Features hand damper mechanism.

William Ludwig Sr. created the first chromatic bell lyra in 1930. Today, Musser Bell Lyras feature satin finished aluminum bars in a choice of sizes. The Lightweight M2040 bars are 1" wide and 1/4" thick. The Standard M2041 bars are 1" wide and 3/8" thick. The Deluxe M2044 bars are 1 1/4" wide and 3/8" thick. All come complete with mallets, plumes, strap and cover. Also available, M8000 wood case and M2051 tilting stand.

Feature Name	M2040 Lightweight	M2041 Standard	M2044 Deluxe
Octave Range	2 Octaves	2 Octaves	2 Octaves
Note Range	A5 - A7	A5 - A7	A5 - A7
Standard Tuning	A=442	A=442	A=442
Option Available	A=440 - A=445	A=440 - A=445	A=440 - A=445
Bar Material	Aluminum	Aluminum	Aluminum
Bar Finish	Satin Silver	Satin Silver	Satin Silver
Bar Dimensions	1" x 1/4" Thick	1" x 3/8" Thick	1 1/4" x 3/8" Thick
Frame	Lightweight	Medium Weight	Extra Duty
Frame Finish	Silver Vein Powder Coat	Silver Vein Powder Coat	Silver Vein Powder Coat
OEM Accessories Included	Plumes, Carrying Strap & Cover	Plumes, Carrying Strap & Cover	Plumes, Carrying Strap & Cover
OEM Mallets	M640	M640	M640
Optional Add-on Stand	M2051	M2051	M2051
Vinyl Cover Add-on Option	M2042	M2042	M2042
Add-on Case	M8000	M8000	M8000
Weight	12 lbs.	15 lbs.	17 lbs.



Height adjustable stand features 1.5" tubing and rubber feet for added stability.

MUSSER CLASSIC CHIMES



MUSSER SYMPHONIC CHIMES



CLASSIC CHIMES

Musser Classic Chimes offer outstanding performance and attractive contemporary features. Twenty carefully crafted 1.25" chime tubes are polished for a bright broad sound or chrome plated for a darker mellower sound. Each seamless tube is individually suspended and fitted with a hardened cap to produce exceptional volume. Frames are finished in a complimenting silver or gold powder coat finish for durability. A damper with wool felt pads can be locked open or pedal operated for precise articulation. Supplied with a rawhide mallet and mallet holder.



Brass tubes produce a rich sound, while chrome delivers a darker, more mellow tone.



The Musser damper system provides complete control.

SYMPHONIC CHIMES

Musser Symphonic Chimes have all the same features as Classic Chimes but with 1.5" tubes for even greater volume and projection. Also available with polished or chrome plated seamless brass tubes, Symphonic Chimes offer the same choice of sound textures but with even more carrying power. Supplied with a rawhide mallet and mallet holder.

Musser Chimes come standard on a concert frame with 3" swivel casters and a pedal operated damper. For outdoor use, all chimes are available on an all terrain cart with 8" pneumatic tires. The all terrain cart features a hand operated damper that is normally "open".

Concert Chimes Feature Name	M661C Symphonic	M665B Symphonic	M635C Classic	M635B Classic
Octave Range	1.5 Octaves	1.5 Octaves	1.5 Octaves	1.5 Octaves
Note Range	C5 - G6	C5 - G6	C5 - G6	C5 - G6
Standard Tuning	A=442	A=442	A=442	A=442
Option Available	A=440 - A=445	A=440 - A=445	A=440 - A=445	A=440 - A=445
Tube Material	Brass	Brass	Brass	Brass
Tube Dimensions	1½" Diameter	1½" Diameter	1¼" Diameter	1¼" Diameter
Tube Finish	Chrome Plated	Polished Brass	Chrome Plated	Polished Brass
Frame Finish	Silver Vein Powder Coated	Gold Vein Powder Coated	Silver Vein Powder Coated	Gold Vein Powder Coated
OEM Mallets	M336	M336	M336	M336
Pro Padded Cover Add-on Option	M166CH	M166CH	M163CH	M163CH
Lined Dust Cover Add-on Option	M266CH	M266Ch	M263CH	M263CH
Height	70"	70"	66"	66"
Width	34"	34"	33"	33"
Bass Depth	24"	24"	24"	24"
Weight	220 lbs.	220 lbs.	166 lbs.	166 lbs.
Chimes on All-Terrain Cart	M661CCT	M665BCT	M635CCT	M635BCT

MUSSER MARCHING MALLET INSTRUMENTS

Musser offers marching mallet instruments with carrying systems to suit a variety of applications. Marching marimbas feature 2 octaves of Kelon® bars that deliver rich tone unaffected by climate conditions. Silver powder coated aluminum resonators are durable and scratch resistant to hold up to rigors of marching conditions.

Marching bells feature aluminum bars in 2.5 octaves. Wood frame has black Plextone finish. Marching xylophones with 2.5 octaves of Kelon® bars are available with no resonators or with silver powder coated aluminum resonators.

Carrying systems for Musser marching mallet instruments include the lightweight, adjustable Omni aluminum carriers that feature padding on the shoulders and stomach to provide added comfort. The two-piece aluminum vest carrier adjusts for size and is padded on the inside for comfort.



Feature Name	M63 Marching Marimba	M65 Marching Bells	M66 Marching Xylophone	M67 Marching Xylophone
Octave Range	2 Octaves	2.5 Octaves	2.5 Octaves	2.5 Octaves
Note Range	C4 - C6	G5 - C8	C5 - G7	C5 - G7
Standard Tuning	A=442	A=442	A=442	A=442
Option Available	A=440 - A=445	A=440 - A=445	A=440 - A=445	A=440 - A=445
Bar Material	Kelon	Kelon	Kelon	Kelon
Bar Graduation	Non-Graduated	Non-Graduated	Non-Graduated	Non-Graduated
Resonators	Aluminum	N/A	N/A	Aluminum
Resonator Shape	Straight	N/A	N/A	Straight
Resonator Finish	Silver Powder Coat	No Resonators	No Resonators	Silver Powder Coat
Frame Style	Wood Frame	Synthetic Frame	Wood Frame	Wood Frame
Frame Finish	Black Plextone	Black Plextone	Black Plextone	Black Plextone
Carrier Option	M63S - Omni M63V - Vest M63NC - No Carrier	M65S - Omni M65V - Vest M65NC - No Carrier	M66S - Omni M66V - Vest M66NC - No Carrier	M67S - Omni M67V - Vest M67NC - No Carrier
OEM Mallets	M2/M4	M4/M5	M4/M5	M4/M5
Add-on Cases	M159, Set of 3	M175, Set of 2	M176, Set of 2	M177, Set of 3
Low End Width	27"	18.5"	22.5"	22.5"
High End Width	17"	9.5"	12.5"	12.5"
Length	31.5"	30.5"	38.5"	38.5"
Weight	55 lbs.	31 lbs.	46 lbs.	53 lbs.

Feature Name	M8063 On M8005 Cart Marimba	M8065 On M8005 Cart Bells	M8066 On M8005 Cart Xylophone	M8067 On M8005 Cart Xylophone
Octave Range	2 Octaves	2.5 Octaves	2.5 Octaves	2.5 Octaves
Note Range	C4 - C6	G5 - C8	C5 - G7	C5 - G7
Standard Tuning	A=442	A=442	A=442	A=442
Option Available	A=440 - A=445	A=440 - A=445	A=440 - A=445	A=440 - A=445
Bar Material	Kelon	Aluminum	Kelon	Kelon
Bar Graduation	Non-Graduated	Non-Graduated	Non-Graduated	Non-Graduated
Resonators	Aluminum	N/A	N/A	Aluminum
Resonator Shape	Straight	N/A	N/A	Straight
Resonator Finish	Silver Powder Coat	No Resonators	No Resonators	Silver Powder Coat
Frame Style	Wood Frame	Synthetic Frame	Wood Frame	Wood Frame
Frame Finish	Black	Black	Black	Black
OEM Mallets	M2, M4	M4, M5	M4, M5	M4, M5
Add-on Cases	M159, Set of 3	M175, Set of 2	M176, Set of 2	M177, Set of 3
Weight	50 lbs.	56 lbs.	75 lbs.	75 lbs.

Vest Carriers

- M2478 Marimba
- M2480 Bells
- M2481 Xylophone

Omni Carriers

- M478 Marimba
- M480 Bells
- M481 Xylophone



MUSSER MALLET CARTS & STANDS



Carts and stands for Musser mallet instruments accommodate a full range of applications, from concert stage to marching field. Many existing mallet instruments can be retrofitted to Musser Moto Carts and All-Terrain Carts.

Moto Cart frames are constructed of tough 2" square tube steel and roll on 5" heavy duty casters. Moto Carts can be fitted with a full range of accessory racks and holders.

All Terrain carts are constructed of 1.25" square tube steel. The M8006 All Terrain Frame rides on 4 - 8" swivel pneumatic wheels and is adjustable to fit instruments from 35" to 63" long.

The versatile M8005 All Terrain cart is ideal for indoor or outdoor use and rides on heavy duty 5" casters. With length adjustment from 28" to 49", any set of Musser orchestra bells or 2 - 2.5 octave marching mallet instrument fits perfectly. Both the M8005 and M8006 All Terrain carts also accept add on accessories like the M8003 trap table or the M8004 crash cymbal cradle. At the front corners, solid posts can accept universal clamps to attach cymbal arms or snare baskets. The M8006 cart can also be fitted with the M8009 front accessory rack.

The LFP302BKS is a versatile stand that can hold small mallet instruments or bass drums.

MUSSER MALLET INSTRUMENT CARTS AND MOTO CART ADD-ON RACKS

- M8001** Moto cart rack system for large mallet instruments. Retrofits to M7007 Moto Cart. Fits M360 and M365 Moto Cart Marimbas to hold bells, cymbals, snare drums, accessories
- M8002** Moto Cart rack system for small mallet instruments. Retrofits to M7001-M7005. Moto Carts fits M7031, M7061, M7055, M7055G, M7046, M7044, M7051, M7042 to hold bells, cymbals, snare drums, accessories
- M8003** Trap table add-on with adapter for M8005 & M8006
- M8004** Crash cymbal holder add-on with adapter for M8005 & M8006
- M8005** Small keyboard cart system with wheels. Designed for M645, M646 bells, M39 xylophone. Designed for M63, M65, M66, M67 Musser marching mallet instruments
- M8006** All-terrain keyboard cart system with 4 swivel pneumatic wheels
- M8007** Timpani cart tote system with pneumatic wheels. Fits any size Ludwig timpani except Machine and Universal models.
- M8008** Chime cart system with pneumatic wheels and hand damper.
- M8009** Rack System for M8006 All Terrain Cart. Holds bells or trap table, cymbal arms, snare drum baskets and accessories.

MOTO CART FRAMES WITHOUT INSTRUMENTS

- (Retrofits the following Musser mallet instruments)
- M7001** Moto Cart frame only for M31 (4 octave) Marimba
- M7002** Moto Cart frame only for M42 and M61 (3 octave) Marimba/Xylophone
- M7003** Moto Cart frame only for M44 (3 octave) Vibe
- M7004** Moto Cart frame only for M51 (3.5 octave) Xylophone
- M7005** Moto Cart frame only for M55, M55G, M46, (3 octave) Vibes
- M7006** Moto Cart frame only for M645 and M646 (2.5 octave) Bells
- M7007** Moto Cart frame only for M360/M300 (4.3 octave) Marimba
- M7350** Moto Cart frame only for M350 (4.5 octave) Marimba

STANDS WITHOUT INSTRUMENTS

- (Retrofits the following Musser mallet instruments)
- LE1368** Fits all Musser Orchestra Bells and M39 Xylophone
- LEP302BKS** Fits all Musser Orchestra Bells and M39 Xylophone



M8008
All-Terrain chime cart features 8" pneumatic wheels, hand damper and front swivel casters.

LM451CH

Modular add-on cymbal holder has tube style ratchets and are adjustable to offer multi-angle positioning.

LM453CLU

Clamps are multi-adaptable to securely attach accessories such as cymbal arms and a snare basket.

M8003

Height adjustable trap table includes adapter to securely hold mallets, sticks and small accessories.

MUSSER MALLET PERCUSSION CART ADD-ON ACCESSORIES

- M8003 Trap Table w/ adapter
- LM453CLU Clamps
- LM451CH Cymbal Arms
- P3931C Snare Basket
- M8004 Crash Cymbal Holder

MUSSER MALLET CARTS ALL-TERRAIN

M8004

Crash cymbal holder keeps cymbals within easy reach.

P3931C

Snare basket accessory allows for 360 degree positioning of the snare drum.

All-Terrain Carts feature large 8" pneumatic wheels on swivel casters which lock in position.

The All-Terrain Mallet Cart (M8006) features large 8" pneumatic wheels which allow the cart to easily roll over rough or smooth terrain. Made of 1 1/4" square steel, the cart is durable and stable. The cart is also height and length adjustable and fits most mallet instruments with a one-piece frame. The All-Terrain Cart is designed for the marching field, but is also suitable for indoor use. To add to the versatility of the cart, add-on accessories are easy to mount securely and are height adjustable. Accessories include a front rack, crash cymbal holder, trap table with adapter, clamps, cymbal arms and snare basket.

M8001

Large rack system fits on All-Terrain Deluxe Moto Cart to accommodate add-on accessories. Shown here on an M501 5-octave marimba.

Rack System add-on for Musser **M8006** All-Terrain Cart system. The **M8009** rack system includes a holder for orchestra bells and four clamps to add cymbal arms, snare baskets and other accessories.

LEGENDARY

THE MAKING OF THE FIRST LUDWIG TIMPANI

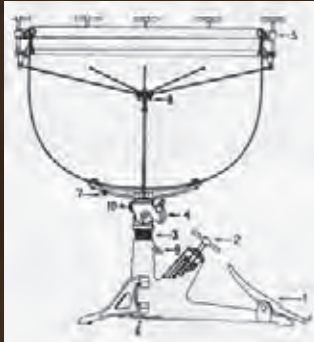

Natural-Way Balanced Action pedal timpani from the 1923 catalog

As timpanist of the Pittsburgh Symphony, William F. Ludwig, Sr. shared a love for the classical works that was only equaled by his passion to perform them on-stage. In 1909, Ludwig, being the purist he was, grew rather frustrated when the hand-tuned timpani of the day made it difficult to play Wagnerian parts to his liking. But it wasn't long before his frustration turned to inspiration. With a more practical, portable pedal-tuned timpani pictured in mind, the accomplished timpanist took on the role of part-time inventor.

Not surprisingly, Ludwig's earliest designs and models failed. Hydraulically operated hoses leaked. Cables stretched. But he was determined and never lost heart – perfecting the music was far too important to him. Then, in 1921, after years of disappointments, he struck perfection. The Balanced Action™ model he developed back then remains to this day the standard in timpani design and sound quality held around the world. You need only to hear the difference in a Ludwig Timpani to judge for yourself. Ludwig's Timpani embody the heart and soul of everyone who plays or dedicates their lives to music. Because just as there's more to playing music than reading notes on a page, there's more to crafting timpani than shaping copper.

An ingenious profile collar extends the head beyond the edge of the kettle to project greater resonance, pitch definition, and easily controlled, accurate tuning. Undisturbed, undistorted tone is the result of the double-ring suspension system and seamless, one-piece angle steel counter hoops.

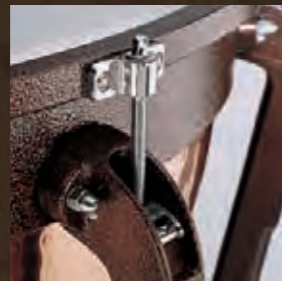

The patented Balanced Action™ tuning pedal moves smoothly through the range. No locks or ratchets are needed to hold pitch.

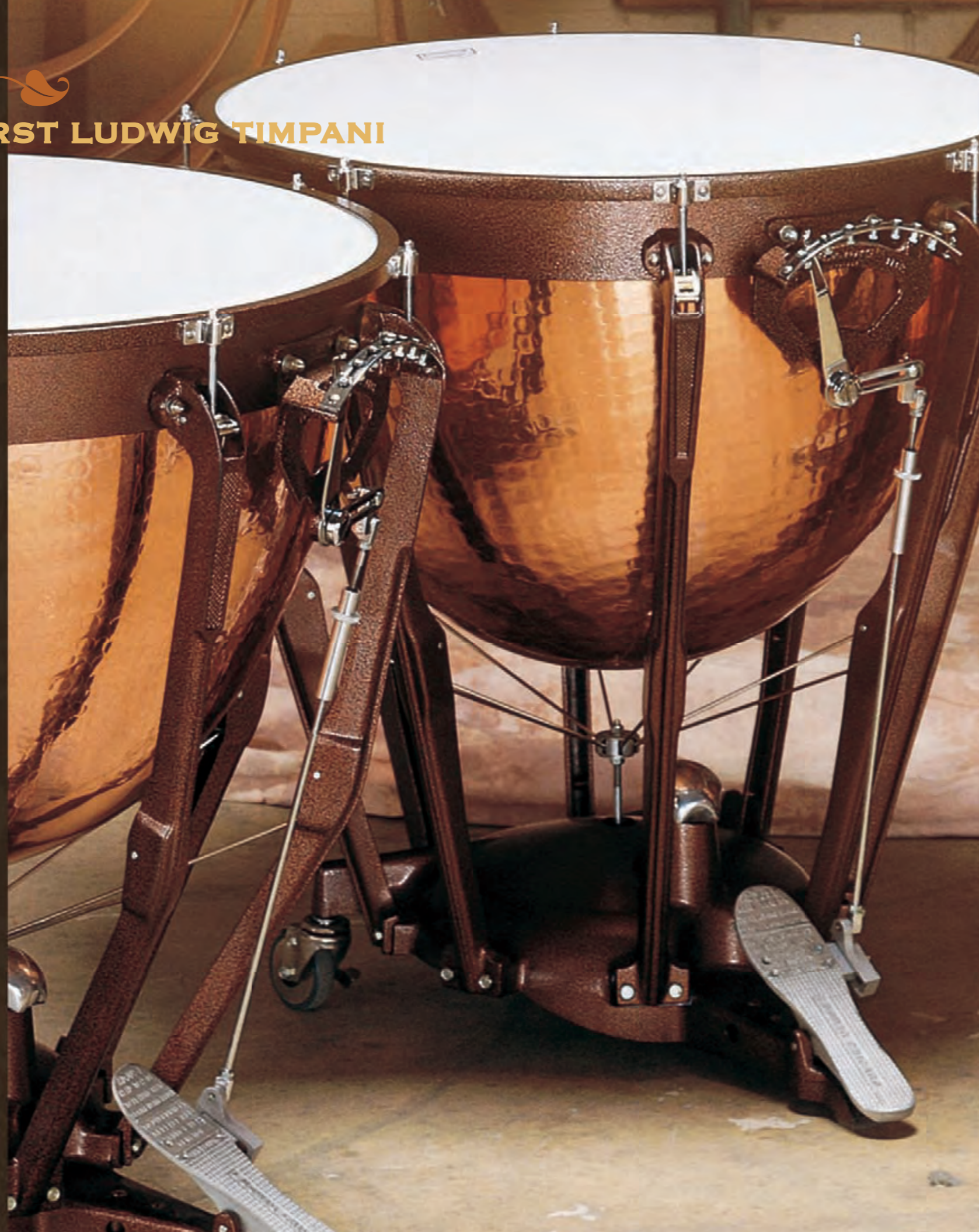

TIMPANI TUNING GAUGES PROFESSIONAL (PEDAL)

MODEL	DESCRIPTION
LKG20	20" Gauge
LKG23	23" Gauge
LKG26	26" Gauge
LKG29	29" Gauge
LKG32	32" Gauge



The Professional Series pedal-operated tuning gauge is accurate, reliable and fully adjustable. With the foot pedal swivel linkage and gauge in front of the player, tuning and adjustment of letters is quick and precise.



THIRD WHEEL TIMPANI ASSEMBLY

FITS GRAND SYMPHONIC, PROFESSIONAL & STANDARD

Model P1423

An all-directional third wheel may be attached under the floor pedal if greater mobility is desired.

TIMPANI TUNING GAUGES STANDARD (HOOP)

MODEL	DESCRIPTION
LKH20	20" Gauge
LKH23	23" Gauge
LKH26	26" Gauge
LKH29	29" Gauge
LKH32	32" Gauge



Standard series tuning gauges are hoop activated for a reliable option for most timpani. Available on all standard, universal and machine models.

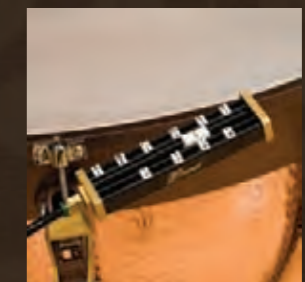

PLANET EXACTONE TIMPANI TUNING GAUGES (EXTERNAL MOUNT SYSTEM)

MODEL	DESCRIPTION
LKP20	20" Gauge
LKP23	23" Gauge
LKP26	26" Gauge
LKP29	29" Gauge
LKP32	32" Gauge
LKP33	One size fits all, Plastic see-thru gauge cover for protection

FOR STANDARD TIMPANI ONLY

MODEL	DESCRIPTION
LKP20	20" Gauge
LKP23	23" Gauge
LKP26S	26" Gauge
LKP29S	29" Gauge



When symphonies are performed at their most glorious levels, it is not without the sweat of rehearsal, week in and week out. Likewise, Ludwig's Grand Symphonic timpani series reflects, in practice, the evolution of design.

To this day, Ludwig's patented Balanced Action™ tuning pedal is widely imitated, yet never matched. The new rolled-lip copper kettle is specially designed to hang within the suspension ring like a bell, extending the range to a 7th of the most overtone-free pitches ever to sound from a timpani. In Ringer fashion, these one-piece bowls are hammered one at a time. Sturdy pull rods are built within the struts for safety and a clean appearance, while friction blocks sit astride the main horizontal pull rod, supporting the balanced action on both ends of the range.

MODEL NO.	DESCRIPTION
LKG720KG	20"/52 cm
LKG723KG	23"/58 cm
LKG726KG	26"/64 cm
LKG729KG	29"/72 cm
LKG732KG	32"/78 cm
LKG705KG	Set of 5
LKG704KG	Set of 4 (23"-32"/58-78 cm)
LKG702KG	Set of 2 (26"-29"/ 64-72 cm)

Fiber head protectors and shallow drop covers are standard. One pair of timpani mallets is standard with each 26" timpani or set of 2, 4 or 5 timpani. A key is included with each drum.

Renaissance timpani heads from Remo are available as an option on Ludwig Grand Symphonic, Professional & Standard timpani only.

LUDWIG GRAND SYMPHONIC SERIES

For more than 35 years Professional Model Timpani have set the standard for performance. Built on the Ludwig Balanced Action Base, Professional series timpani are available in your choice of Hammered Copper, Polished Copper or Fiberglass bowls. Each bowl is suspended freely inside a suspension ring to give great depth of tone.

LUDWIG PROFESSIONAL SERIES

M8007

Timpani Tote Cart is ideal for marching bands and drum corps performances on the field. Even on rough terrain, the timpani roll smoothly. The cart features 8" pneumatic back wheels with 5" front swivel casters and fits Ludwig Grand Symphonic, Professional and Standard Timpani.



HAMMERED COPPER	POLISHED COPPER	FIBERGLASS	DESCRIPTION
LKP520KG	LKP520PG	LKP520AG	20"
LKP523KG	LKP523PG	LKP523FG	23"
LKP526KG	LKP526PG	LKP526FG	26"
LKP529KG	LKP529PG	LKP529FG	29"
LKP532KG	LKP532PG	LKP532FG	32"
LKG505KG	LKP505PG	LKP505FG	Set of 5
LKG504KG	LKP504PG	LKP504FG	Set of 4 (23"-32")
LKG502KG	LKP502PG	LKP502FG	Set of 2 (26" & 29")

Professional Series Timpani may be ordered without tuning gauges. Delete suffix "G" from model number.

Fiber head protectors and shallow drop covers are standard. One pair of timpani mallets is standard with each 26" timpani or set of 2, 4 or 5 timpani. A key is included with each drum.

Renaissance timpani heads from Remo are available as an option on Ludwig Grand Symphonic, Professional & Standard timpani only.



LUDWIG STANDARD SYMPHONIC SERIES



LUDWIG MACHINE SERIES

The Machine Model provides quick tuning and a fiberglass kettle designed in the same parabolic deep shape as our high-end models. The sturdy metal legs can be telescoped into the kettle, for storage or transport.



MACHINE SERIES FIBERGLASS KETTLE

W/ STANDARD GAUGE	W/O GAUGE	DESCRIPTION
LKM220AH	LKM220A*	20"
LKM223AH	LKM223F	23"
LKM226AH	LKM226F	26"
LKM229AH	LKM229F	29"
LKM232AH	LKM232F	32"
LKM205AH	LKM205F	Set of 5
LKM204AH	LKM204F	Set of 4 (23"-32")
LKM202AH	LKM202F	Set of 2 (26" & 29")

*Note: 20" kettle is aluminum.

LUDWIG UNIVERSAL SERIES



The Ludwig Universal Model provides a deep parabolic bowl of molded fiberglass for resonance and affordability. The Universal Model uses our Balanced Action tuning system contained in the pedestal mount which can be removed from the bowl and folded for storage or transport.

UNIVERSAL SERIES FIBERGLASS KETTLE

W/ STANDARD GAUGE	W/O GAUGE	DESCRIPTION
LKU320AH*	LKU320A*	20"
LKU323FH	LKU323F	23"
LKU326FH	LKU326F	26"
LKU329FH	LKU329F	29"
LKU332FH	LKU332F	32"
LKU305FH	LKU305F	Set of 5
LKU304FH	LKU304F	Set of 4 (23"-32")
LKU302FH	LKU302F	Set of 2 (26" & 29")

*Note: 20" kettle is aluminum.

Upon arriving home after his wartime service, Wm. F. Ludwig II discovered his father, William, Sr., quietly working away on yet another revolutionary timpani design. At that time, timpani were mounted on a pedestal. Instead, William, Sr. successfully mounted a kettle on support struts like the original Dresden design. Then, he added his original design of the floor pedal with Balanced Action™ tuning – promptly naming it the Symphonic model.

Today, it is estimated that there are more Standard Symphonic timpani in use throughout the world than all other models and brands combined.

POLISHED COPPER	FIBERGLASS	DESCRIPTION
LKS420PG	LKS420AG*	20"
LKS423PG	LKS423FG	23"
LKS426PG	LKS426FG	26"
LKS429PG	LKS429FG	29"
LKS432PG	LKS432FG	32"
LKS405PG	LKS405FG	Set of 5
LKS404PG	LKS404FG	Set of 4 (23"- 32")
LKS402PG	LKS402FG	Set of 2 (26" & 29")

*Note: 20" Kettle is aluminum.

Fiber head protectors and shallow drop covers are standard. One pair of timpani mallets is standard with each 26" timpani or set of 2, 4 or 5 timpani. A key is included with each drum.

Renaissance timpani heads from Remo are available as an option on Ludwig Grand Symphonic, Professional & Standard timpani only.

Ludwig's hoop activated tuning gauges are a reliable option that works well with most timpani. Available on all Standard, Universal and Machine models. Remove the "G" and add an "H" to the model number.



LUDWIG TIMPANI FEATURES GUIDE

FEATURE	GRAND SYMPHONIC SERIES	PROFESSIONAL SERIES	STANDARD SERIES	UNIVERSAL SERIES	MACHINE SERIES
Tuning System	Balanced Action Pedal™	Balanced Action Pedal™	Balanced Action Pedal™	Balanced Action Pedal™	Single Screw
Range	7th	6th	6th	6th	5th
20" Diameter	F3-E4	F3-D4	F3-D4	F3-D4	F3-C4
23" Diameter	D3-C3	D3-B3	D3-B3	D3-B3	D3-A3
26" Diameter	A2-G3	A2-F3	A2-F3	A2-F3	A2-E3
29" Diameter	E2-D3	E2-C3	E2-C3	E2-C3	F2-C3
32" Diameter	D2-C2	D2-B2	D2-B2	D2-B2	D2-A2
Tuning Mechanics	Outside Bowl	Outside Bowl	Inside Bowl	Inside Bowl	Inside Bowl
Suspended Bowl	Yes	Yes	N/A	N/A	N/A
Tuning Gauge Option	Professional Direct	Professional Direct	Professional Direct or Standard Hoop Gauge	Standard Hoop Gauge	Standard Hoop Gauge
Bowl Material	Copper	Copper/Fiberglass	Copper/Fiberglass	Fiberglass	Fiberglass
Hammered Copper Bowl	Only Option	Option	N/A	N/A	N/A
Base Style	Full Base Casting	Full Base Casting	Full Base Casting	Folding Legs	3 Telescoping Legs
Shallow Drop Covers	Standard	Standard	Standard	Standard	Standard
Drumheads					
Ludwig Weather Master Smooth	Standard	Standard	Standard	Standard	Standard
White Mylar					
Remo® Renaissance	Option	Option	Option	N/A	N/A

LUDWIG CONCERT BASS

These powerful drums feature specially designed die-molded shells that are cross-laminated and constructed of nine-ply maple. The result is a full, unmistakably pure Ludwig sound. Additional features include triple chrome-plating, self-aligning lugs, all-wood hoops, smooth white Weather Master or Remo® Fiberskyn drum heads and optional wood-stained finishes.



LE788 suspended all terrain bass drum stand



Strong poly straps suspend the drum for maximum resonance. The pressure fit tilting device holds position securely.



The LE788 Suspended All-Terrain Bass Drum Stand Tilts 360° to any angle for maximum performance. Adjustable foot rest for proper muffling technique.



LECB86X8WF
18x36 Bass drum w/ LE788 suspended stand and Remo® Fiberskyn Heads.

FINISHES FOR CONCERT BASS

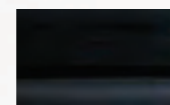

(G) Black Cortex

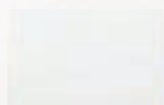

(F) White Cortex



(E) Mahogany Cortex



(L) Cherry



(N) Maple

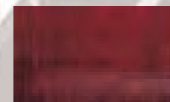

(M) Mahogany

ALL-TERRAIN TILTING BASS DRUM STAND

The LE787 All-Terrain Tilting Bass Drum Stand tilts 360 degrees, is height adjustable and fits 28"-40" drums. Ideal for middle school. Includes foot rest and locking 5" casters.

SUSPENDED ALL-TERRAIN BASS DRUM STAND

Ludwig's premier stand is made from 1.5" square steel tubing and has no drum-to-metal contact for rattle-free sound between the drum and the stand. Free suspension offers increased projection and superb resonance at all dynamic levels. Other features include fully variable tilting adjustment with reliable angle locking casters, for 32" to 40" drums. The LE788 is silver powder coated for maximum durability. For proper bass drum performance and muffling a retractable and adjustable foot rest is featured along with large 5" wheels for easy transportation in the band room, concert hall or marching field.

BASS DRUM ONLY

MODEL NO. SMOOTH WHITE HEADS	REMO® FIBERSKYN HEADS	DESCRIPTION
LECB28XX	LECB28XX_WF	14" x 28"
LECB32XX	LECB32XX_WF	16" x 32"
LECB36XX	LECB36XX_WF	16" x 36"
LECB86XX	LECB86XX_WF	18" x 36"
LECB62XX	LECB62XX_WF	20" x 36"
LECB40XX	LECB40XX_WF	18" x 40"

BASS DRUM W/ LE788 ALL-TERRAIN SUSPENDED STAND

MODEL NO. SMOOTH WHITE HEADS	REMO® FIBERSKYN HEADS	DESCRIPTION
LECB32X8	LECB32X8_WF	16" x 32"
LECB36X8	LECB36X8_WF	16" x 36"
LECB86X8	LECB86X8_WF	18" x 36"
LECB62X8	LECB62X8_WF	20" x 36"
LECB40X8	LECB40X8_WF	18" x 40"

BASS DRUM W/ LE787 TILTING BASS DRUM STAND

MODEL NO. SMOOTH WHITE HEADS	REMO® FIBERSKYN HEADS	DESCRIPTION
LECB28X7	LECB28X7_WF	14" x 28"
LECB32X7	LECB32X7_WF	16" x 32"
LECB36X7	LECB36X7_WF	16" x 36"
LECB86X7	LECB86X7_WF	18" x 36"
LECB62X7	LECB62X7_WF	20" x 36"
LECB40X7	LECB40X7_WF	18" x 40"

BASS DRUM STANDS

MODEL NO.	DESCRIPTION
LE788	All-Terrain Stand - Fits 32"- 40" Drums
LE790	Folding Stand - Fits 28" - 36" Drums
LE787	All-Terrain Tilting Stand - Fits 28"-40" Drums

LUDWIG CONCERT TOMS

Ludwig's seven-ply maple shells produce outstanding projection and tonal definition. Strong chrome-plated lugs and triple-flanged hoops are standard. Each single headed concert tom is fitted with a durable protective trim on the bottom edge. Plus, our classic double-tom stands are completely angle-adjustable, ball and socket adjustment and large serrated rubber feet.

FINISHES FOR CONCERT TOMS



LUDWIG LATIN PERCUSSION

CONCERT TOM SETS (SET OF 4 DRUMS W/2 STANDS)

MODEL NO.	DESCRIPTION	RANGE
LECT62CC	6", 8", 10", 12"	High Range w/ Stands
LECT04CC	10", 12", 13", 14"	Mid Range w/ Stands
LECT36CC	13", 14", 15", 16"	Low Range w/ Stands

COMPONENT CONCERT TOM - SINGLE HEADED

MODEL NO.	DESCRIPTION
LCS396LM	6"
LCS398LM	8"
LCS390LM	10"
LCS312LM	12"
LCS323LM	13"
LCS334LM	14"
LCS345LM	15"
LCS356LM	16"

DOUBLE TOM STAND FOR CONCERT TOMS

MODEL NO.	DESCRIPTION
LC342TSR	Single Brace Legs L-Arm Holder Style



TIMBALES SET W/ STAND & COWBELL

MODEL NO.	STEEL CHROME-PLATED	BRASS	DESCRIPTION
LETB02C		LETB02B	10" & 12"
LETB34C		LETB34B	13" & 14"
LM440TBS			Timbale Stand Only
L189			Timbale Cover

BONGOS

Ludwig Tunable Bongos will give your percussion section an authentic Latin touch. Perfect for hand or stick applications on bongos. Made with 7-ply birch shells, classic lugs, and smooth white Weather Master high collar drum heads.

BONGOS*

MODEL NO.	DESCRIPTION	STAND/MOUNT
LE2357	6" & 8"	w/ Stand
LE2358	6" & 8"	w/ Mounting Block Only
LE1346	Bongo Stand	

*Indicate finish

TIMBALES

Ludwig steel chrome-plated or brass timbales feature durable timbale stand, cowbell and removable cowbell holder. Designed for an authentic Latin sound, Ludwig timbales offer a resonating shell for stick applications and coated white timbale heads for superior drum tones.

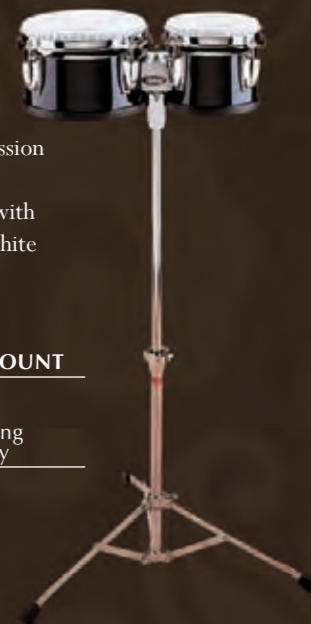



LUDWIG

EDUCATIONAL KITS



M652RBR
LUDWIG BELL KIT WITH ROLLING BAG

COMPONENTS

- 2.5 Oct. (F – C) Aluminum Bells
- Tunable Practice Pad
- Combination Stand
- Sticks
- Mallets
- Music Rack
- Durable Rolling Bag



LE2483RBR
LUDWIG COMBO KIT WITH ROLLING BAG

COMPONENTS

- 3x13" Wood Snare Drum
- 2.5 Oct. (F – C) Aluminum Bells
- Tunable Practice Pad
- Combination Stand
- Sticks
- Mallets
- Music Rack
- Durable Rolling Bag

LE2477RBR
LUDWIG DRUM KIT WITH ROLLING BAG

COMPONENTS

- 5x14" Metal Shell Snare Drum
- Rubber Practice Pad
- Snare Stand
- Sticks
- Durable Rolling Bag

New Rolling Bag Design features durable rubber wheels, telescoping pull handle, stylish black & red padded nylon material with heavy duty zippers.



MUSSER PADUAK PRACTICE MARIMBA

M3PM MUSSER PADUAK PRACTICE MARIMBA

The M3PM is the ideal Practice Marimba. Three octaves of Paduak bars graduated and spaced to match our larger instruments support proper 4-mallet practice.

- 3 Octave Graduated Paduak Bars
- Portable & Lightweight
- Standard with multi-height X-Frame Stand
- Optional Rolling Carrying Bag Available (M3PMB)
- Designed for the advancing mallet percussionist



M3PM



Hooked posts to secure bars.



Beautiful Paduak bars for a full-bodied tone.



Multi-height X-Frame stand allows comfort for player.



Shown with standard cover (included) to protect from dust when not in use.



Easy to store when not in use. Shown with optional rolling carrying bag. (M3PMB)

MUSSER XYLO KITS

The M47 Xylo Kit features Musser Kelon® bars with the same 1.5" width and 3.5 octave range as our professional xylophones. Lightweight folding legs are height adjustable and diagonally braced for stability making this the perfect practice instrument. Also available with 3 octave range as M41.

M47 – Musser 3.5 Octave Xylo Kit

M41 – Musser 3 Octave Xylo Kit



M47



M41



L398MP

A complete array of essential mallets is included in the L398MP percussion accessory bag. The set includes one pair of LSD1 concert drumsticks, L195 wire brushes, L306 Payson General Timpani Mallets, M4 Musser Bell/Xylophone Mallets and M8 Yarn Wound Marimba/Vibe Mallets.

MUSSER MALLET

Finest grade materials are used for each Musser mallet and are carefully balanced for flex, weight, size and tonal response. Good Vibes® are recognized as the world's finest professional mallets. Light rattan handles are selected and matched for size, weight and flex. Heads are made of premium yarn which is wound around a solid, specially formulated and shaped rubber core, then carefully hand-stitched.

Two Step mallets are Musser's exclusive fiberglass handle design that is thicker near the end and thinner near the head for strong striking force and well-balanced handling. Two Step mallets offer excellent flexibility and warp resistance. Precision matched for balance, mallets are available in rubber, plastic, metal and wood balls and cord or yarn-covered balls.

Birch handle mallets are ideal for the market player who prefers a straight but firmer wood handle. Heads with rubber, plastic or yarn are precision matched for balance.

CHIME MALLET



CHIME MALLET

- M336 Rawhide Chime Mallet
- M337 Dual Head Chime Mallet Features removable heads for a variety of chime tonal color.
- E0341 Chime Mallet Holder Attaches to a chime frame.

RATTAN HANDLE

- M214 X, B Rubber, Med. 1" Gray
- M213 X, B Rubber, Med. Hard 1" Blue
- M212 X, M Rubber, Med. 1" Blue
- M224 M Rubber, Med. Soft 1" Blue
- M211 M Rubber, Soft 1" Yellow
- M205 M Rubber, Med. Soft 1 1/4" Yellow

- M203 X, B Lexan, Very Hard 1 1/8" Clear
- M215 X, B Phenolic, Hard 1" Brown
- M227 X, B Nylon, Hard 1" White
- M225 X, B Poly Ball, Med. Hard 1" White
- M226 X, B Poly Ball, Med. Hard 1 1/8" White

- M216 V Cord, Hard 1" Red
- M217 V Cord, Med. 1" Blue
- M218 V Cord, Soft 1" Yellow

- M206 X Yarn, Hard 1" Red
- M207 M Yarn, Med. 1" Blue
- M208 M Yarn, Med. Soft 1" Yellow
- M222 M Yarn, Soft 1" Green
- M219 V Cord, Med. Hard 1 1/4" Red
- M209 M Yarn, Soft 1 1/8" Brown
- M210 M Yarn, Soft 1 1/4" Brown
- M223 M Yarn, Very Soft 1 1/4" Brown
- M204 M Yarn, Soft 1 1/8" White

- M220 V, M Yarn, Soft 1 1/8" Black (Set of 4)
- M221 V, M Yarn, Med. Hard 1 1/8" Gold (Set of 4)

TWO STEP

- M23 X, B Lexan, Very Hard 1 1/8" Clear
- M24 X, B Phenolic, Hard 1 1/8" Brown
- M5 X, B Phenolic, Hard 1" Brown
- M28 X, B Phenolic, Hard 1" Black
- M15 X Wood, Hard 1" Maple
- M14 B Brass, Very Hard 5/8" Gold (Steel Bells)

- M16 V Cord, Hard 1" Red
- M17 V Cord, Med. 1" Blue
- M18 V Cord, Soft 1" Yellow
- M27 V Cord, Med. Hard 1 1/4" Red
- M29 V Cord, Med. 1 1/4" Yellow

- M6 X Yarn, Hard 1" Red
- M7 M Yarn, Med. 1" Blue
- M8 M Yarn, Med. Soft 1" Yellow
- M11 M Yarn, Soft 1" Green
- M9 M Yarn, Soft 1 1/8" Brown
- M10 M Yarn, Soft 1 1/4" Brown
- M12 M Yarn, Very Soft 1 3/8" Brown
- M19 M Yarn, Med. Soft 1" White

- M4 X, B Rubber, Med. 1" Gray
- M3 X, B Rubber, Med. 1" Blue
- M2 X Rubber, Med. 1" Red
- M22 X, B Rubber, Hard 1 1/8" Gray
- M25 M Rubber, Med. Soft 1" Black
- M1 M Rubber, Soft 1" Yellow
- M13 M Rubber, Med. Soft 1 1/4" Yellow

GOOD VIBES

- M232 X, V, M Yarn, Hard 1 1/8" Black (Set of 4)
- M231 X Yarn, Hard 1 1/8" Brown (Set of 4)
- M239 V, M Yarn, Med. Hard 1 1/2" Green (Set of 4)
- M236 V, M Yarn, Hard 1 3/8" Red (Set of 4)
- M237 V, M Yarn, Med. Hard 1 7/16" Violet (Set of 4)
- M235 V, M Yarn, Med. Hard 1 3/8" Royal Blue (Set of 4)
- M233 V, M Yarn, Med. Soft 1 3/8" Pink (Set of 4)
- M229 V, M Yarn, Med. Hard 1 3/8" Yellow (Set of 4)
- M228 V, M Yarn, Med. Soft 1 3/16" Navy Blue (Set of 4)

BIRCH HANDLE

- M423 X, B Lexan, Very Hard 1 1/8" Clear
- M424 X, B Phenolic, Hard 1 1/8" Black
- M405 X, B Phenolic, Hard 1" Brown
- M4227 X, B Nylon, Hard 1 1/8" White
- M428 X, B Phenolic, Hard 1" Black
- M4226 X, B Poly Ball, Med. Hard 1 1/8" White
- M4224 X, B Poly Ball, Med. Hard 1" White

- M406 X Yarn, Hard 1" Red
- M407 M Yarn, Med. 1" Blue
- M408 M Yarn, Med. Soft 1" Yellow
- M411 M Yarn, Soft 1" Green
- M409 M Yarn, Soft 1 1/8" Brown
- M410 M Yarn, Soft 1 1/4" Brown
- M412 M Yarn, Very Soft 1 3/8" Brown

- M404 X, B Rubber, Hard 1" Gray
- M403 X, B Rubber, Med. Hard 1" Blue
- M402 X, M Rubber, Med. 1" Red
- M401 M Rubber, Soft 1" Yellow
- M413 M Rubber, Med. Soft 1 1/4" Yellow

LUDWIG MALLET, HEADS & ACCESSORIES

Ludwig offers a full line of concert bass drum and timpani mallets for the total percussionist, including the incomparable Payson mallets custom-made to the specifications of acclaimed percussionist Al Payson. Payson mallets feature maple shafts and superior felt for perfect tone production.



Ludwig Weather Master drum heads feature the patented Headlock® system for pure tone and durability.

BASS DRUM HEADS

MODEL NO.	WHITE COATED	CLEAR	SMOOTH WHITE	DESCRIPTION
LW4328	LW4128	LW4228	LW4228	28"
LW4330	LW4130	LW4230	LW4230	30"
LW4332	LW4132	LW4232	LW4232	32"
LW4334	LW4134	LW4234	LW4234	34"
LW4336	LW4136	LW4236	LW4236	36"
LW4340	LW4140	LW4240	LW4240	40"

TIMPANI HEADS

Size	EXTENDED COLLAR		REGULAR COLLAR		RINGER	
	White	Clear	White	Clear	White	Clear
20"/51 cm	C8220	C8120	C9220	C9120	C8252	C8152
23"/59 cm	C8223	C8123	C9223	C9123	C8258	C8158
25"/64 cm			C9225	C9125		
26"/66 cm	C8226	C8126	C9226	C9126	C8264	C8164
28"/71 cm			C9228	C9128		
29"/74 cm	C8229	C8129	C9229	C9129	C8272	C8172
30"/76 cm			C9230	C9130		
32"/81 cm	C8232	C8132	C9232	C9132	C8278	C8178
Use	All drums made after 1978		For Standard, Universal and Machine made prior to 1978		Plastic Only	

SPECIALITY HEADS

MODEL NO.	DESCRIPTION	SIZE
C11206	Bongo	6"
C11208	Bongo	8"
CTB10	Timbale	10"
CTB12	Timbale	12"
CTB13	Timbale	13"
CTB14	Timbale	14"

TIMPANI TUNING KEY - P15011



DRUM KEY - P41

LUDWIG TIMPANI MALLET

MODEL NO.	DESCRIPTION
L304	Ultra Soft Pile w/Maple Handles (Payson Model)
L305	Soft Pile w/Maple Handles (Payson Model)
L306	Medium Felt, General Purpose w/Maple Handles (Payson Model)
L307	Hard Felt, Staccato w/Maple Handles (Payson Model)
L2311	Medium Hard Felt w/Aluminum Handles

LUDWIG CONCERT BASS DRUM AND GONG MALLET

MODEL NO.	DESCRIPTION
L308	"Sostenuto Model" Soft Brown Pile (Payson Model)
L309	"Roller" Soft Brown Pile (Payson Model)
L310	"General Purpose" Soft White Felt (Payson Model)
L319	"Double Ball" Soft Black Pile on Wooden Shaft
L2320	Acrolite Shaft Black Pile Covered Double Ball
L326	Gong/Tam-Tam Mallet

CONCERT SNARE DRUM STANDS

MODEL NO.	DESCRIPTION
LC623SSC	Classic Single Brace Concert Snare Stand w/ Extension
LM923SSC	Modular Double Brace Concert Snare Stand w/ Extension
LR1369CXT	Classic Snare Stand Extension (7/8")
LM1394CXT	Modular Snare Stand Extension (1")
LAP923SSC	Atlas Pro Pillar Clutch Concert Snare Stand

TIMPANI TUNING GAUGES PROFESSIONAL (PEDAL)

MODEL	DESCRIPTION
LKG20	20" Gauge
LKG23	23" Gauge
LKG26	26" Gauge
LKG29	29" Gauge
LKG32	32" Gauge



The Professional Series pedal-operated tuning gauge is accurate, reliable and fully adjustable. With the foot pedal swivel linkage and gauge in front of the player, tuning and adjustment of letters is quick and precise.



THIRD WHEEL TIMPANI ASSEMBLY

FITS GRAND SYMPHONIC, PROFESSIONAL & STANDARD

Model P1423

An all-directional third wheel may be attached under the floor pedal if greater mobility is desired.



Gig bags for the M48 Pro-Traveler Vibe feature 5 padded compartmentalized bags for safe transport.



M137



M138

MUSSER

CASES, GIG BAGS, & COVERS

Cases and covers are constructed to take the wear and tear of travel and keep instruments safe. Designed with tough, durable materials, padding, metal corners and heavy duty straps.

The M137B Pro-Travler set includes 5 padded nylon bags for M48 Pro-Travler vibraphone.

Bar cases (M137B) with heavy duty shells have a wide adjustable strap for added security, while M139 bag is a lightweight woven nylon bag with heavy duty zippers.

Mallet instrument cases incorporate wide straps to securely protect the contents in the case. Metal corners add structural durability.

MARIMBA CASES

FIBER CASES

M135	Fits M61 (Set of 2)
M136	Fits M31, M32 (Set of 2)
M148	Fits M250 (Set of 5)
M155	Fits M350 (Set of 5)
M157	Fits M300 (Set of 5)

MARIMBA ATA TRUNKS

M150	Fits M450 (Set of 3)
M151	Fits M500 (Set of 3)

XYLOPHONE CASES

FIBER CASES

M146	Fits M51, M50 (Set of 3)
M147	Fits M42 (Set of 2)

VIBRAPHONE CASES

FIBER CASES

M138	Fits M48 (Set of 3)
M141	Fits M75 (Set of 5)
M149	Fits M55 (Set of 3)
M180	Fits M44 (Set of 2)
M258	Fits M58 (Set of 3) ATA Style

MARCHING MALLET INSTRUMENT CASES

FIBER CASES

M159	Fits M63V, M63S (Set of 3)
M174	Carrier Case Only
M175	Fits M65V, M65S (Set of 2)
M176	Fits M66V, M66S (Set of 2)
M177	Fits M67V, M67S (Set of 3)



M137B
Padded bar bag for any set of full, wide graduated vibe bars.

M139
Fiber bar case for any set of full wide graduated vibe bars.

SHALLOW VINYL
DUST COVER



PADDED FABRIC FULL
PROFESSIONAL COVER



FLANNEL-LINED
VINYL FULL COVER



Musser mallet instrument covers are available in a choice of three styles, including the shallow vinyl dust cover, padded fabric full professional cover and flannel-lined vinyl full cover.

Chime covers are important for keeping the instrument dust free and fully protected when not in use. Professional covers are full length, padded and made of durable, long-lasting Cordura. For a lighter cover, there is a full-length vinyl dust cover that fits Musser chimes. Lined dust covers for chimes are also available in shallow sizes.

VIBRAPHONE COVERS

PADDED PRO COVERS - FULL DROP - CORDURA

M155VB	Fits M55, M58, M48, M75, M46
M144VB	Fits M44

LINED DUST COVERS - FULL DROP - VINYL

M255VB	Fits M55, M58, M48, M75, M46
M244VB	Fits M44

LIGHT DUST COVERS - VINYL

M165	Fits M55, M58, M46
M167	Fits M75
M172	Fits M44

XYLOPHONE COVERS

PADDED PRO COVERS - FULL DROP - CORDURA

M151XY	Fits M51, M50
M142XY	Fits M42

LINED DUST COVERS - FULL DROP - VINYL

M251XY	Fits M51, M50
M242XY	Fits M42

LIGHT DUST COVERS - VINYL

M164	Fits M51, M50
M162	Fits M42

MARIMBA COVERS

PADDED PRO COVERS - FULL DROP - CORDURA

M130B	Fits M250, M300, M240
M135MB	Fits M350, M365
M145MB	Fits M450
M136MB	Fits M360
M161MB	Fits M61
M131MB	Fits M31, M32

LINED DUST COVERS - FULL DROP - VINYL

M230B	Fits M250, M300, M240
M235MB	Fits M350, M365
M245MB	Fits M450
M236MB	Fits M360
M261MB	Fits M61
M231MB	Fits M31, M32

LIGHT DUST COVERS - VINYL

M169	Fits M250, M300, M240, M245
M171	Fits M350, M360
M168	Fits M450
M166	Fits M61
M170	Fits M31, M32
M156	Fits M500 Only

CHIME COVERS

PADDED PRO COVERS - FULL DROP - CORDURA

M166CH	Fits M661C, M665B - 1½" tube chimes
M163CH	Fits M635C, M635B - 1¼" tube chimes

PADDED PRO COVERS - FULL DROP - VINYL

M266CH	Fits M661C, M665B - 1½" tube chimes
M263CH	Fits M635C, M635B - 1¼" tube chimes

LINED DUST COVERS - SHALLOW DROP - VINYL

M637	Fits M661C, M665B - 1½" tube chimes
M636	Fits M635C, M635B - 1¼" tube chimes



M637



M636



M266CH
M263CH



M166CH
M163CH

MUSSER

CASES, GIG BAGS, & COVERS

LUDWIG

CASES & COVERS

CONCERT BASS DRUM COVERS

Cordura construction offers long-lasting durability for years of use. Padded pro covers offer as much protection as a case

MODEL NO.		
PADDED PRO COVERS FULL DROP - CORDURA	LINED DUST COVERS FULL DROP - CORDURA	DESCRIPTION
L1632CB	L2632CB	Fits 16x32" Drum w/ Stand
L1836CB	L2836CB	Fits 16x36" & 18x36" Drum w/ Stand
L1840CB	L2840CB	Fits 18x40" Drum w/ Stand
L2036CB	L3620CB	Fits 20x36" Drum w/ Stand

TIMPANI TRUNKS

Custom fitted trunks are designed with five-ply wood panels, steel corners and edges, and heavily padded holding blocks to keep your timpani safe and secure.

MODEL NO.	
ALL LUDWIG MODELS	DESCRIPTION
L1621	Fits 20"
L1626	Fits 23"
L1631	Fits 26"
L1641	Fits 29"
L1636	Fits 32"



M8007

TIMPANI TOTE CART

Timpani Tote Cart is ideal for marching bands and drum corps performances on the field. Even on rough terrain, the timpani roll smoothly. The cart features 8" pneumatic back wheels with 5" front swivel casters and fits Ludwig Grand Symphonic, Professional and Standard Timpani.



FULL DROP PADDED PRO COVER



FULL DROP LIGHT DUST COVER



SHALLOW DROP LINED DUST COVER

TIMPANI COVERS

Custom fitted, heavy gauge vinyl or Cordura construction. Your choice of full or shallow drop.

MODEL NO.					
PADDED PRO COVER FULL DROP - CORDURA	LINED DUST COVERS FULL DROP - VINYL	LIGHT DUST COVERS FULL DROP - VINYL	LIGHT DUST COVERS SHALLOW - VINYL	DESCRIPTION	
L120TP	L220TP	L144	L196	Fits 20" Timpani	
L123TP	L223TP	L145	L197	Fits 23" Timpani	
L126TP	L226TP	L131	L198	Fits 26" Timpani	
L129TP	L229TP	L135	L199	Fits 29" Timpani	
L132TP	L232TP	L147	L200	Fits 32" Timpani	



LE787

ALL TERRAIN TILTING BASS DRUM STAND

Tilts 360 degrees and fits 28" - 40" drums. Features foot rest and locking 5" casters. Comes with mounting hardware as shown.



LE790

FOLDING STAND

Simple to fold and store, this metal stand offers dependable support. Felt sleeves insulate the drum for pure sound and provide a no-slip grip. Adjusts to fit 28" - 36" drums.